

Z120 Continental Gas

ENGINE INFORMATION

Z120 Continental Gas

4 Cyl.

Bore: 3.187" to 3.312", 4 ring piston



DESCRIPTION	PART NO.
MAJOR OH KIT	A-OK257
IN FRAME OH KIT	A-IK257

For Models: (TRACTOR: TE20, TO20)

ENGINE COMPONENT PARTS

NOTICE: Parts included in the overhaul kits are indicated as follows:

M parts included in MAJOR OVERHAUL KITS

I parts included in IN FRAME OVERHAUL KITS



DESCRIPTION	PART NO.	SIZE	QTY	KIT
Piston Liner Kit	A-SK106		4	MI
Piston	A-PA61		4	
Liner, Cylinder	A-SW222		4	
Sealing Ring Kit, Liner	A-SRK715		4	
Rings, Piston	A-PR121		4	
Rings, Piston ¹	A-836092M1		1	



DESCRIPTION	PART NO.	SIZE	QTY	KIT
Bearing Set, Main (3)	A-830511M91	STD	1	M
Bearing Set, Main (3)	A-34K60010	.010	1	M
Bearing Set, Main (3)	A-34K60020	.020	1	M
Bearing Set, Main (3)	A-34K60030	.030	1	M
Bearing Set, Main (3)	A-830633M1	STD	1	M
Bearing Set, Main (3)	A-34K61010	.010	1	M
Bearing Set, Main (3)	A-34K61020	.020	1	M
Bearing Set, Main (3)	A-34K61030	.030	1	M



DESCRIPTION	PART NO.	SIZE	QTY	KIT
Bearing, Conn Rod	A-830486M91	STD	4	MI
Bearing, Conn Rod	A-830508M91	.002	4	MI
Bearing, Conn Rod	A-830509M91	.010	4	MI
Bearing, Conn Rod	A-830510M91	.020	4	MI
Bearing, Conn Rod	A-83051030	.030	4	MI



DESCRIPTION	PART NO.	SIZE	QTY	KIT
Bushing, Conn Rod	A-760916M1		4	M



DESCRIPTION	PART NO.	SIZE	QTY	KIT
Seal, Rear Main	A-1750216M1		1	M
Seal, Front Crankshaft	A-015287A		1	M
Seal, Front Dust	A-015288A		1	M
Gasket, Rear Engine	A-1750112M1		1	
Oil Seal Retainer ²				
Seal, Rear Main (Rope)	A-1006635M1		1	

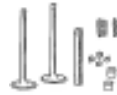

DESCRIPTION	PART NO.	SIZE	QTY	KIT
Valve Train Kit	A-VTK257		1	
Valve, Intake	A-1751518M1		4	
Valve, Exhaust (Pin Type)	A-1751519M1		4	
Guide Set, Valve (8)	A-830490M1		1	
Spring, Valve	A-021176A		8	
Pin, Valve ⁴	A-018291A		4	
Keeper, Valve ⁵	A-1004512M1		16	



DESCRIPTION	PART NO.	SIZE	QTY	KIT
Gasket OH Set w/o Seals	A-830631M1		1	MI
Gasket, Upper Set	A-836426M1		1	
Gasket, Pan	A-1750024M1		1	
Gasket, Head	A-1750336M1		1	



DESCRIPTION	PART NO.	SIZE	QTY	KIT
Thermostat (160°)	A-181634M1		1	



DESCRIPTION	PART NO.	SIZE	QTY	KIT
Assembly Lube; 8oz	A-10152		1	
Assembly lube; Case of 12-8oz bottles	A-10153		1	

Parts are not original equipment parts and are not sponsored, affiliated, or otherwise connected with any major brand.

- ALLIS CHALMERS
- CASE-IH
- CATERPILLAR
- CLARK
- DEUTZ
- FIAT
- FORD / NEW HOLLAND
- GEHL
- HYSTER
- IMT
- INGERSOLL RAND
- JACOBSEN
- JCB
- JOHN DEERE
- LANDINI
- LEYLAND
- LINCOLN ELECTRIC
- MASSEY FERGUSON
- MELROE
- MICHIGAN
- OWATTONA
- PERKINS USA
- RENAULT
- SULAIR CORP
- VERMEER
- WHITE/ OLIVER
- ZETOR

1) For Standard 3 3/16" Bore Piston. Set for 1 engine 2) Use w/ A-1750216M91 Seal 3) pin type 4) intake pin 5) roto type exhaust

Z129 Continental Gas

ENGINE INFORMATION

Z129 Continental Gas
4 Cyl.
Bore: 3.25" to 3.375", 4 ring piston

	DESCRIPTION	PART NO.
CLARK	MAJOR OH KIT	A-OK258
	IN FRAME OH KIT	A-IK258

ENGINE COMPONENT PARTS

NOTICE: Parts included in the overhaul kits are indicated as follows:
 M parts included in MAJOR OVERHAUL KITS
 I parts included in IN FRAME OVERHAUL KITS

	DESCRIPTION	PART NO.	SIZE	QTY	KIT
HYSTER	Piston Liner Kit	A-SK105		4	MI
	Piston	A-PA180		4	
	Liner, Cylinder	A-SW182		4	
	Sealing Ring Kit, Liner	A-SRK715		4	
	Rings, Piston	A-PR123		4	
JACOBSSEN	Rings, Piston ¹	A-836097M1		1	
	DESCRIPTION	PART NO.	SIZE	QTY	KIT
JCB	Bearing Set, Main (3) ⁶	A-830511M91	STD	1	M
	Bearing Set, Main (3) ⁶	A-34K60010	.010	1	M
	Bearing Set, Main (3) ⁶	A-34K60020	.020	1	M
JOHN DEERE	Bearing Set, Main (3) ⁶	A-34K60030	.030	1	M
	Bearing Set, Main (3) ⁵	A-830633M1	STD	1	M
LANDINI	Bearing Set, Main (3) ⁵	A-34K61010	.010	1	M
	Bearing Set, Main (3) ⁵	A-34K61020	.020	1	M
LEYLAND	Bearing Set, Main (3) ⁵	A-34K61030	.030	1	M
	DESCRIPTION	PART NO.	SIZE	QTY	KIT
LINCOLN ELECTRIC	Bearing, Conn Rod	A-830486M91	STD	4	MI
	Bearing, Conn Rod	A-830508M91	.002	4	MI
	Bearing, Conn Rod	A-830509M91	.010	4	MI
	Bearing, Conn Rod	A-830510M91	.020	4	MI
MASSEY FERGUSON	Bearing, Conn Rod	A-83051030	.030	4	MI
	DESCRIPTION	PART NO.	SIZE	QTY	KIT
MELROE	Bushing, Conn Rod	A-760916M1		4	M
	DESCRIPTION	PART NO.	SIZE	QTY	KIT
MICHIGAN	Seal, Rear Main	A-1750216M1		1	M
	Seal, Front Crankshaft	A-015287A		1	M
	Seal, Front Dust	A-015288A		1	M
OWATTONA	Gasket, Rear Engine	A-1750112M1		1	
	Oil Seal Retainer ²				
PERKINS USA	Seal, Rear Main (Rope)	A-1006635M1		1	
RENAULT					
SULAIR CORP					
VERMEER					
WHITE/OLIVER					
ZETOR					



DESCRIPTION	PART NO.	SIZE	QTY	KIT
Valve Train Kit (Std)	A-VTK258		1	
Valve, Intake ³	A-1750070M1		4	
Valve, Exhaust ⁴	A-1750072M1		4	
Guide Set, Valve (8)	A-830490M1		8	
Spring, Valve	A-021176A		8	
Pin, Valve ³	A-018291A		4	
Keeper, Valve ⁴	A-1004512M1		4	

DESCRIPTION	PART NO.	SIZE	QTY	KIT
Gasket OH Set w/o Seals	A-830631M1		1	MI
Gasket, Upper Set	A-836426M1		1	
Gasket, Pan	A-1750024M1		1	
Gasket, Head	A-1750336M1		1	

DESCRIPTION	PART NO.	SIZE	QTY	KIT
Thermostat (160°)	A-181634M1		1	

DESCRIPTION	PART NO.	SIZE	QTY	KIT
Assembly Lube; 8oz	A-10152		1	
Assembly lube; Case of 12-8oz bottles	A-10153		1	

Parts are not original equipment parts and are not sponsored, affiliated, or otherwise connected with any major brand.

1) For Std. Bore 3 1/4 piston, set for 1 Engine 2) Use w/ A-1750216M91 Seal 3) intake pin 4) roto type exhaust 5) w/ single flange front brg. 6) w/ straight shell front brg. Thrust washer included.

Parts are not original equipment parts and are not sponsored, affiliated, or otherwise connected with any major brand.

ENGINE INFORMATION

Z134 Continental Gas

4 Cyl.

Bore: 3.312" to 3.375", 4 ring piston



DESCRIPTION	PART NO.
MAJOR OH KIT	A-OK259
IN FRAME OH KIT	A-1K259

For Models: (TRACTOR: F40, 135, T035), (INDUSTRIAL/CONSTRUCTION: 202, 204), (TRACTOR: 35, 50)

ENGINE COMPONENT PARTS

NOTICE: Parts included in the overhaul kits are indicated as follows:

M parts included in MAJOR OVERHAUL KITS

I parts included in IN FRAME OVERHAUL KITS



DESCRIPTION	PART NO	SIZE	QTY	KIT
Piston Liner Kit	A-SK105		4	MI
Piston	A-PA180		4	
Liner, Sealing Ring Kit	A-SRK715		4	
Liner, Cylinder	A-SW182		4	
Rings, Piston	A-PR123		4	



DESCRIPTION	PART NO	SIZE	QTY	KIT
Bearing Set, Main (3)	A-837155M91	STD	1	M
Bearing Set, Main (3)	A-837156M91	.010	1	M
Bearing Set, Main (3)	A-830639M91	.020	1	M
Bearing Set, Main (3)	A-34K62030	.030	1	M



DESCRIPTION	PART NO	SIZE	QTY	KIT
Bearing, Conn Rod	A-830486M91	STD	4	MI
Bearing, Conn Rod	A-830508M91	.002	4	MI
Bearing, Conn Rod	A-830509M91	.010	4	MI
Bearing, Conn Rod	A-830510M91	.020	4	MI
Bearing, Conn Rod	A-83051030	.030	4	MI



DESCRIPTION	PART NO	SIZE	QTY	KIT
Bushing, Conn Rod	A-760916M1		4	M



DESCRIPTION	PART NO	SIZE	QTY	KIT
Valve Train Kit (Std)	A-VTK258		1	
Valve, Intake ¹	A-1750070M1		4	
Valve, Exhaust ²	A-1750072M1		4	
Guide Set, Valve (8)	A-830490M1		8	
Spring, Valve	A-021176A		8	
Pin, Valve ¹	A-018291A		4	
Keeper, Valve ²	A-1004512M1		4	



DESCRIPTION	PART NO	SIZE	QTY	KIT
Seal, Front Crankshaft	A-015287A		1	
Seal, Rear Main	A-1750216M1		1	

Z134 Continental Gas



DESCRIPTION	PART NO	SIZE	QTY	KIT
Gasket OH Set w/Seals	A-830689M1		1	MI
Gasket, Upper Set	A-836287M1		1	
Gasket, Pan	A-1750024M1		1	
Gasket, Head	A-1750017M1		1	



DESCRIPTION	PART NO	SIZE	QTY	KIT
Thermostat (180°) ³	A-836000M1		1	
Thermostat (180°) ⁴	A-1446165M91		1	



DESCRIPTION	PART NO	SIZE	QTY	KIT
Assembly Lube; 8oz	A-10152		1	
Assembly lube; Case of 12-8oz bottles	A-10153		1	

ALLIS CHALMERS

CASE-IH

CATERPILLAR

CLARK

DEUTZ

FIAT

FORD / NEW HOLLAND

GEHL

HYSTER

IMT

INGERSOLL RAND

JACOBSEN

JCB

JOHN DEERE

LANDINI

LEYLAND

LINCOLN ELECTRIC

MASSEY FERGUSON

MELROE

MICHIGAN

OWATTONA

PERKINS USA

RENAULT

SULAIR CORP

VERMEER

WHITE/OLIVER

ZETOR

1) intake pin 2) roto type exhaust 3) for T035, MF35, F40, & MF50 4) for MF135

Z145 Continental Gas

ENGINE INFORMATION

Z145 Continental Gas
Z145 Continental Gas, 4 Cyl
Bore: 3.375", 4 ring piston

DESCRIPTION	PART NO.
MAJOR OH KIT	A-OK260
IN FRAME OH KIT	A-IK260

For Models: (TRACTOR: 135, 150)

ENGINE COMPONENT PARTS

NOTICE: Parts included in the overhaul kits are indicated as follows:
 M parts included in MAJOR OVERHAUL KITS
 I parts included in IN FRAME OVERHAUL KITS

DESCRIPTION	PART NO.	SIZE	QTY	KIT
Piston Liner Kit	A-SK104		4	MI
Piston	A-PA181		4	
Liner, Cylinder	A-SW183		4	
Sealing Ring Kit, Liner	A-SRK715		4	
Rings, Piston	A-PR122		4	
DESCRIPTION	PART NO.	SIZE	QTY	KIT
Bearing Set, Main (3)	A-837155M91	STD	1	M
Bearing Set, Main (3)	A-837156M91	.010	1	M
Bearing Set, Main (3)	A-830639M91	.020	1	M
Bearing Set, Main (3)	A-34K62030	.030	1	M
DESCRIPTION	PART NO.	SIZE	QTY	KIT
Bearing, Conn Rod	A-830486M91	STD	4	MI
Bearing, Conn Rod	A-830508M91	.002	4	MI
Bearing, Conn Rod	A-830509M91	.010	4	MI
Bearing, Conn Rod	A-830510M91	.020	4	MI
Bearing, Conn Rod	A-83051030	.030	4	MI
DESCRIPTION	PART NO.	SIZE	QTY	KIT
Bushing, Conn Rod	A-760916M1		4	M
DESCRIPTION	PART NO.	SIZE	QTY	KIT
Valve Train Kit (Std)	A-VTK258		1	
Valve, Intake	A-1027654M1		4	
Valve, Exhaust ¹	A-1750072M1		4	
Guide Set, Valve (8)	A-830490M1		8	
Spring, Valve	A-021176A		8	
Pin, Valve ²	A-018291A		4	
Keeper, Valve ¹	A-1004512M1		4	
DESCRIPTION	PART NO.	SIZE	QTY	KIT
Gasket OH Set w/Seals	A-830689M1		1	MI
Gasket, Upper Set	A-836287M1		1	
Gasket, Pan	A-1750024M1		1	
Gasket, Head	A-1750017M1		1	

DESCRIPTION	PART NO.	SIZE	QTY	KIT
Thermostat (180°) ³	A-1446165M91		1	

DESCRIPTION	PART NO.	SIZE	QTY	KIT
Starter	A-1107512		1	

DESCRIPTION	PART NO.	SIZE	QTY	KIT
Assembly Lube; 8oz	A-10152		1	
Assembly lube; Case of 12-8oz bottles	A-10153		1	

Parts are not original equipment parts and are not sponsored, affiliated, or otherwise connected with any major brand.

1) roto type exhaust 2) intake pin 3) for MF135

ENGINE INFORMATION

G176 Gas

4 Cyl.

Bore: 3.578", 4 ring piston



DESCRIPTION	PART NO.
MAJOR OH KIT	A-OK261
IN FRAME OH KIT	A-OIK261

For Models: (INDUSTRIAL/CONSTRUCTION: 3165)

ENGINE COMPONENT PARTS

NOTICE: Parts included in the overhaul kits are indicated as follows:

M parts included in MAJOR OVERHAUL KITS

I parts included in IN FRAME OVERHAUL KITS



DESCRIPTION	PART NO.	SIZE	QTY	KIT
Piston Liner Kit	A-SK119		4	MI
Piston ¹⁾	A-PA360		4	
Liner, Cylinder	A-SW362		4	
Sealing Ring Kit, Liner	A-SRK715		4	
Rings, Piston	A-PR133		4	



DESCRIPTION	PART NO.	SIZE	QTY	KIT
Bearing Set, Main (3)	A-830752M91	STD	1	M
Bearing Set, Main (3)	A-830754M91	.010	1	M
Bearing Set, Main (3)	A-830755M91	.020	1	M



DESCRIPTION	PART NO.	SIZE	QTY	KIT
Bearing, Conn Rod	A-830748M91	STD	4	MI
Bearing, Conn Rod	A-830750M91	.010	4	MI
Bearing, Conn Rod	A-830751M91	.020	4	MI



DESCRIPTION	PART NO.	SIZE	QTY	KIT
Bushing, Conn Rod	A-1753787M1		4	M



DESCRIPTION	PART NO.	SIZE	QTY	KIT
Valve Train Kit	A-VTK261		1	
Valve, Intake	A-1019742M1		4	
Valve, Exhaust	A-1019743M1		4	
Guide, Valve	A-1019739M1		8	
Spring, Valve	A-1010268M1		8	
Keeper, Valve	A-841375M1		8	



DESCRIPTION	PART NO.	SIZE	QTY	KIT
Gasket OH Set w/Seals	A-830766M1		1	MI
Gasket, Upper Set	A-836283M1		1	
Gasket, Pan	A-1753804M1		1	



DESCRIPTION	PART NO.	SIZE	QTY	KIT
Assembly Lube; 8oz	A-10152		1	
Assembly lube; Case of 12-8oz bottles	A-10153		1	

Parts are not original equipment parts and are not sponsored, affiliated, or otherwise connected with any major brand.

1) dome head piston

- ALLIS CHALMERS
- CASE-IH
- CATERPILLAR
- CLARK
- DEUTZ
- FIAT
- FORD / NEW HOLLAND
- GEHL
- HYSTER
- IMT
- INGERSOLL RAND
- JACOBSEN
- JCB
- JOHN DEERE
- LANDINI
- LEYLAND
- LINCOLN ELECTRIC
- MASSEY FERGUSON
- MELROE
- MICHIGAN
- OWATTONA
- PERKINS USA
- RENAULT
- SULAIR CORP
- VERMEER
- WHITE/ OLIVER
- ZETOR

H260 Continental Gas

ENGINE INFORMATION

H260 Continental Gas
OVER BORE: 4"



DESCRIPTION	PART NO.
IN FRAME OH KIT	A-1K265

For Models: 44 SERIES 1946-1954

ENGINE COMPONENT PARTS

NOTICE: Parts included in the overhaul kits are indicated as follows:

M parts included in MAJOR OVERHAUL KITS

I parts included in IN FRAME OVERHAUL KITS

DESCRIPTION	PART NO.	SIZE	QTY	KIT
Piston Liner Kit	A-SK122		4	M
Piston	A-PA280		4	
Liner, Cylinder	A-SW282		4	
Rings, Piston	A-PR173		4	

DESCRIPTION	PART NO.	SIZE	QTY	KIT
Bearing, Conn Rod	A-1001189M92	STD	4	M

DESCRIPTION	PART NO.	SIZE	QTY	KIT
Bushing, Conn Rod	A-760196M1		4	

DESCRIPTION	PART NO.	SIZE	QTY	KIT
Gasket OH Set w/o Seals	A-OGSH260		1	M
Gasket, Upper Set	A-HGSH260		1	

DESCRIPTION	PART NO.	SIZE	QTY	KIT
Guide, Valve	A-835987M91		8	
Key, Valve Keeper ¹	A-840759M91		8	

DESCRIPTION	PART NO.	SIZE	QTY	KIT
Assembly Lube; 8oz	A-10152		1	
Assembly lube; Case of 12-8oz bottles	A-10153		1	

Parts are not original equipment parts and are not sponsored, affiliated, or otherwise connected with any major brand.

¹) key type

ENGINE INFORMATION

20C

4 CYL

STD BORE: 3.188"

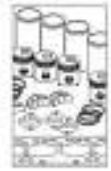

DESCRIPTION	PART NO.
MAJOR OH KIT	A-OK20C
IN FRAME OH KIT	A-IK20C

For Models: TEF20

ENGINE COMPONENT PARTS

NOTICE: Parts included in the overhaul kits are indicated as follows:

M parts included in MAJOR OVERHAUL KITS

I parts included in IN FRAME OVERHAUL KITS



DESCRIPTION	PART NO.	SIZE	QTY	KIT
Piston Liner Kit (4)	A-SK146		1	MI



DESCRIPTION	PART NO.	SIZE	QTY	KIT
Bearing Set, Main	A-830897M91	STD	1	M
Bearing Set, Main	A-830898M91	.010	1	M
Bearing Set, Main	A-894944M91	.020	1	M
Bearing Set, Main	A-894945M91	.030	1	M



DESCRIPTION	PART NO.	SIZE	QTY	KIT
Bearing Set, Conn Rod	A-830899M91	STD	1	MI
Bearing Set, Conn Rod	A-830900M91	.010	1	MI
Bearing Set, Conn Rod	A-830901M91	.020	1	MI
Bearing Set, Conn Rod	A-894947M91	.030	1	MI



DESCRIPTION	PART NO.	SIZE	QTY	KIT
Seal, Front Crankshaft	A-825740M1		1	M
Seal, Rear Crankshaft	A-1884098M1		1	M

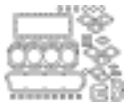

DESCRIPTION	PART NO.	SIZE	QTY	KIT
Gasket, Upper Set	A-106387		1	MI
Gasket, Lower Set	A-894916M91		1	MI



DESCRIPTION	PART NO.	SIZE	QTY	KIT
Pump, Fuel Lift Transfer	A-826154M91		1	



DESCRIPTION	PART NO.	SIZE	QTY	KIT
Assembly Lube; 8oz	A-10152		1	
Assembly lube; Case of 12-8oz bottles	A-10153		1	

Parts are not original equipment parts and are not sponsored, affiliated, or otherwise connected with any major brand.

- ALLIS CHALMERS
- CASE-IH
- CATERPILLAR
- CLARK
- DEUTZ
- FIAT
- FORD / NEW HOLLAND
- GEHL
- HYSTER
- IMT
- INGERSOLL RAND
- JACOBSEN
- JCB
- JOHN DEERE
- LANDINI
- LEYLAND
- LINCOLN ELECTRIC
- MASSEY FERGUSON
- MELROE
- MICHIGAN
- OWATTONA
- PERKINS USA
- RENAULT
- SULAIR CORP
- VERMEER
- WHITE/ OLIVER
- ZETOR

80MM

ENGINE INFORMATION

80MM

4 CYL

STD BORE: 3.15"



DESCRIPTION	PART NO.
MAJOR OH KIT	A-OK80MM
IN FRAME OH KIT	A-IK80MM

For Models: TEA20

ENGINE COMPONENT PARTS

NOTICE: Parts included in the overhaul kits are indicated as follows:

M parts included in MAJOR OVERHAUL KITS

I parts included in IN FRAME OVERHAUL KITS

DESCRIPTION	PART NO.	SIZE	QTY	KIT
Piston Liner Kit	A-SK145		1	MI
Piston	A-58141		4	
Rings, Piston	A-PR120		4	
Liner, Cylinder	A-825138M1		4	

DESCRIPTION	PART NO.	SIZE	QTY	KIT
Bearing Set, Main	A-825840M1	STD	1	M
Bearing Set, Main	A-825837M1	.010	1	M
Bearing Set, Main	A-825982M1	.020	1	M
Bearing Set, Main	A-825983M1	.030	1	M

DESCRIPTION	PART NO.	SIZE	QTY	KIT
Bearing Set, Conn Rod	A-1810083M91	STD	1	MI
Bearing Set, Conn Rod	A-1810084M91	.010	1	MI
Bearing Set, Conn Rod	A-1810085M91	.020	1	MI
Bearing Set, Conn Rod	A-1810086M91	.030	1	MI

DESCRIPTION	PART NO.	SIZE	QTY	KIT
Bushing, Conn Rod	A-RB875		4	M

DESCRIPTION	PART NO.	SIZE	QTY	KIT
Seal, Crankshaft Front	A-825740M1		1	M
REAR CRNK OIL SEAL	A-825208M1		1	M

DESCRIPTION	PART NO.	SIZE	QTY	KIT
Guide, Intake Valve	A-825259M1		8	

DESCRIPTION	PART NO.	SIZE	QTY	KIT
TOP GSKT SET	A-501923		1	MI
Gasket, Lower Set	A-894915M91		1	MI
Gasket	A-825654M1		1	

DESCRIPTION	PART NO.	SIZE	QTY	KIT
Assembly Lube; 8oz	A-10152		1	
Assembly lube; Case of 12-8oz bottles	A-10153		1	

Parts are not original equipment parts and are not sponsored, affiliated, or otherwise connected with any major brand.

ENGINE INFORMATION

85MM

4 CYL

STD BORE: 3.346"



DESCRIPTION	PART NO.
MAJOR OH KIT	A-OK85MM
IN FRAME OH KIT	A-IK85MM

For Models: TEA20, TED20

ENGINE COMPONENT PARTS

NOTICE: Parts included in the overhaul kits are indicated as follows:

M parts included in MAJOR OVERHAUL KITS

I parts included in IN FRAME OVERHAUL KITS



DESCRIPTION	PART NO.	SIZE	QTY	KIT
Piston Liner Kit	A-SK132		4	MI
Piston	A-1883817M91		4	
Rings, Piston	A-836118M91		4	
Liner, Cylinder	A-893007M1		4	



DESCRIPTION	PART NO.	SIZE	QTY	KIT
Bearing Set, Main	A-825840M1	STD	1	M
Bearing Set, Main	A-825837M1	.010	1	M
Bearing Set, Main	A-825982M1	.020	1	M
Bearing Set, Main	A-825983M1	.030	1	M



DESCRIPTION	PART NO.	SIZE	QTY	KIT
Bearing Set, Conn Rod	A-1810083M91	STD	1	MI
Bearing Set, Conn Rod	A-1810084M91	.010	1	MI
Bearing Set, Conn Rod	A-1810085M91	.020	1	MI
Bearing Set, Conn Rod	A-1810086M91	.030	1	MI



DESCRIPTION	PART NO.	SIZE	QTY	KIT
Bushing, Conn Rod	A-RB875		4	M



DESCRIPTION	PART NO.	SIZE	QTY	KIT
Seal, Front Crankshaft	A-825740M1		1	M
Seal, Rear Crankshaft	A-825208M1		1	M



DESCRIPTION	PART NO.	SIZE	QTY	KIT
Valve, Intake	A-825388M1		4	
Valve, Exhaust	A-825651M1		4	
Guide, Intake Valve	A-825259M1		8	

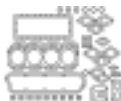

DESCRIPTION	PART NO.	SIZE	QTY	KIT
Gasket, Upper Set	A-501923		1	MI
Gasket, Lower Set	A-894915M91		1	MI
Gasket	A-825654M1		1	



DESCRIPTION	PART NO.	SIZE	QTY	KIT
Assembly Lube; 8oz	A-10152		1	
Assembly lube; Case of 12-8oz bottles	A-10153		1	

Parts are not original equipment parts and are not sponsored, affiliated, or otherwise connected with any major brand.

- ALLIS CHALMERS
- CASE-IH
- CATERPILLAR
- CLARK
- DEUTZ
- FIAT
- FORD / NEW HOLLAND
- GEHL
- HYSTER
- IMT
- INGERSOLL RAND
- JACOBSEN
- JCB
- JOHN DEERE
- LANDINI
- LEYLAND
- LINCOLN ELECTRIC
- MASSEY FERGUSON
- MELROE
- MICHIGAN
- OWATTONA
- PERKINS USA
- RENAULT
- SULAIR CORP
- VERMEER
- WHITE/ OLIVER
- ZETOR

87MM

ENGINE INFORMATION

87MM

4 CYL

STD BORE: 3.425"



DESCRIPTION	PART NO.
MAJOR OH KIT	A-OK87MM
IN FRAME OH KIT	A-IK87MM

For Models: 135 UK, FE35

ENGINE COMPONENT PARTS

NOTICE: Parts included in the overhaul kits are indicated as follows:

M parts included in MAJOR OVERHAUL KITS

I parts included in IN FRAME OVERHAUL KITS



DESCRIPTION	PART NO.	SIZE	QTY	KIT
Piston Liner Kit	A-SK142		4	MI
Piston	A-826276M91		4	
Liner, Cylinder	A-825861M1		4	
Rings, Piston	A-PR200		4	



DESCRIPTION	PART NO.	SIZE	QTY	KIT
Bearing Set, Main	A-825840M1	STD	1	M
Bearing Set, Main	A-825837M1	.010	1	M
Bearing Set, Main	A-825982M1	.020	1	M
Bearing Set, Main	A-825983M1	.030	1	M



DESCRIPTION	PART NO.	SIZE	QTY	KIT
Bearing Set, Conn Rod	A-1810083M91	STD	1	MI
Bearing Set, Conn Rod	A-1810084M91	.010	1	MI
Bearing Set, Conn Rod	A-1810085M91	.020	1	MI
Bearing Set, Conn Rod	A-1810086M91	.030	1	MI



DESCRIPTION	PART NO.	SIZE	QTY	KIT
Bushing, Conn Rod	A-RB875		4	M



DESCRIPTION	PART NO.	SIZE	QTY	KIT
Seal, Front Crankshaft	A-825740M1		1	M
Seal, Rear Crankshaft	A-825208M1		1	M



DESCRIPTION	PART NO.	SIZE	QTY	KIT
Guide, Intake Valve	A-825259M1		8	



DESCRIPTION	PART NO.	SIZE	QTY	KIT
Gasket, Upper Set	A-827560M91		1	MI
Gasket, Lower Set	A-894915M91		1	MI
Gasket	A-825654M1		1	



DESCRIPTION	PART NO.	SIZE	QTY	KIT
Assembly Lube; 8oz	A-10152		1	
Assembly lube; Case of 12-8oz bottles	A-10153		1	

Parts are not original equipment parts and are not sponsored, affiliated, or otherwise connected with any major brand.

Parts are not original equipment parts and are not sponsored, affiliated, or otherwise connected with any major brand.

ENGINE INFORMATION

Standard Diesel

4 CYL., 23C

5 RING PISTON, LIP SEAL, BORE 3.31"



DESCRIPTION	PART NO.
MAJOR OH KIT	A-OK142
IN FRAME OH KIT	A-IK142

For Models: (TRACTOR: T035, 35X, FE35)

ENGINE COMPONENT PARTS

NOTICE: Parts included in the overhaul kits are indicated as follows:

M parts included in MAJOR OVERHAUL KITS

I parts included in IN FRAME OVERHAUL KITS



DESCRIPTION	PART NO	SIZE	QTY	KIT
Piston Liner Kit (4)	A-SK148		1	MI
Piston	A-1884101M1		4	
Liner, Cylinder	A-1884940M1		4	
Rings, Piston	A-836117M91		4	



DESCRIPTION	PART NO	SIZE	QTY	KIT
Bearing Set, Main	A-830897M91	STD	1	M
Bearing Set, Main	A-830898M91	.010	1	M
Bearing Set, Main	A-894944M91	.020	1	M
Bearing Set, Main	A-894945M91	.030	1	M



DESCRIPTION	PART NO	SIZE	QTY	KIT
Bearing Set, Conn Rod	A-830899M91	STD	1	MI
Bearing Set, Conn Rod	A-830900M91	.010	1	MI
Bearing Set, Conn Rod	A-830901M91	.020	1	MI
Bearing Set, Conn Rod	A-894947M91	.030	1	MI



DESCRIPTION	PART NO	SIZE	QTY	KIT
Seal, Front Crankshaft	A-825740M1		1	
Seal, Rear Crankshaft	A-1884098M1		1	



DESCRIPTION	PART NO	SIZE	QTY	KIT
Valve, Intake	A-1884123M1		4	
Valve, Exhaust	A-1884124M1		4	
Guide, Intake Valve	A-825259M1		8	
Guide, Exhaust Valve	A-826162M1		8	
Spring, Valve Outer	A-1884125M1		8	
Chain, Timing	A-826094M1		1	



DESCRIPTION	PART NO	SIZE	QTY	KIT
Gasket OH Set w/Seals	A-3A62FS		1	M
Gasket, Upper Set	A-1810028M91		1	I
Gasket, Lower Set	A-1810027M91		1	I



DESCRIPTION	PART NO	SIZE	QTY	KIT
Repair Kit, Oil Pump (23C)	A-826059M91		1	



DESCRIPTION	PART NO	SIZE	QTY	KIT
Pump, Fuel Lift Transfer	A-1884857M91		1	



DESCRIPTION	PART NO	SIZE	QTY	KIT
Assembly Lube; 8oz	A-10152		1	
Assembly lube; Case of 12-8oz bottles	A-10153		1	

ALLIS CHALMERS

CASE-IH

CATERPILLAR

CLARK

DEUTZ

FIAT

FORD / NEW HOLLAND

GEHL

HYSTER

IMT

INGERSOLL RAND

JACOBSEN

JCB

JOHN DEERE

LANDINI

LEYLAND

LINCOLN ELECTRIC

MASSEY FERGUSON

MELROE

MICHIGAN

OWATTONA

PERKINS USA

RENAULT

SULAIR CORP

VERMEER

WHITE/OLIVER

ZETOR

3.152

ENGINE INFORMATION

3.152

INDIRECT INJECTION ^ 3 CYL ROPE SEAL

BORE: 3.6020" 91.491mm



DESCRIPTION	PART NO.
MAJOR OH KIT	A-OK301
IN FRAME OH KIT	A-IK301

For Models: (TRACTOR: (35, 50 ALL Eng SN <1935853)), (INDUSTRIAL/CONSTRUCTION: (203, 205, 35 UTILITY ALL Eng SN <1935853))

ENGINE COMPONENT PARTS

NOTICE: Parts included in the overhaul kits are indicated as follows:

M parts included in MAJOR OVERHAUL KITS

I parts included in IN FRAME OVERHAUL KITS

DESCRIPTION	PART NO	SIZE	QTY	KIT
Piston Liner Kit	A-CK152		3	MI
Piston ¹	A-81512		3	
Liner, Cylinder (.040" Flange) ²	A-31358308		3	
Liner, Cylinder (Finished Cast) 3.152	A-31358308/CST		3	
Rings, Piston	A-41158058		3	
DESCRIPTION	PART NO	SIZE	QTY	KIT
Bearing Set, Main (4)	A-68084	STD	1	M
Bearing Set, Main (4)	A-68084A	.010	1	M
Bearing Set, Main (4)	A-68084B	.020	1	M
Bearing Set, Main (4)	A-68084C	.030	1	M
DESCRIPTION	PART NO	SIZE	QTY	KIT
Bearing Set, Conn Rod	A-85036	STD	1	MI
Bearing Set, Conn Rod	A-85036A	.010	1	MI
Bearing Set, Conn Rod	A-85036B	.020	1	MI
Bearing Set, Conn Rod	A-85036C	.030	1	MI
DESCRIPTION	PART NO	SIZE	QTY	KIT
Washer Set, Thrust (4)	A-31137211/21	STD	1	M
Washer Set, Thrust (4)	A-735800M1	.007	1	M
Washer, Thrust	A-TWK152		1	
DESCRIPTION	PART NO	SIZE	QTY	KIT
Seal, Front Crankshaft	A-2415344		1	M
Seal, Rear Crankshaft	A-36883106		2	M
Crankshaft	A-ZZ90116		1	
DESCRIPTION	PART NO	SIZE	QTY	KIT
Valve Train Kit	A-VTK301		1	M
Valve, Intake	A-31431261		3	
Valve, Exhaust	A-0910002		3	
Guide, Intake & Exhaust Valve	A-33261723		6	
Spring, Valve Outer	A-0780006		6	
Lock, Valve	A-0230001		6	



DESCRIPTION	PART NO	SIZE	QTY	KIT
Bushing, Conn Rod	A-31134151		3	M
Bolt, Conn Rod	A-0095250		6	MI
Nut, Conn Rod	A-33221327		6	MI
Connecting Rod ^{3,6}	A-ZZ90011		3	

DESCRIPTION	PART NO	SIZE	QTY	KIT
Gasket, Upper Set	A-U5LT0012		1	MI
Gasket, Lower Set w/o Seal	A-U5LB0012		1	MI
Gasket, Head	A-36812136		1	

DESCRIPTION	PART NO	SIZE	QTY	KIT
Camshaft	A-31415261		1	
Tappet	A-0860012		6	
Shaft, Rocker	A-ZZ90047		1	
Rocker Arm, LH	A-3737A101		3	
Arm, RH Rocker	A-3737A091		3	

DESCRIPTION	PART NO	SIZE	QTY	KIT
Gear, Crankshaft ⁴	A-0410132		1	
Gear, Camshaft Timing	A-731203M1		1	
Idler Gear, Camshaft	A-731205M2		1	

DESCRIPTION	PART NO	SIZE	QTY	KIT
Pump, Oil	A-41314078		1	
Pump, Fuel Lift ⁵	A-2641408		1	

DESCRIPTION	PART NO	SIZE	QTY	KIT
Assembly Lube; 8oz	A-10152		1	
Assembly lube; Case of 12-8oz bottles	A-10153		1	

Parts are not original equipment parts and are not sponsored, affiliated, or otherwise connected with any major brand.

1) flat head piston 2) cast sleeve replaces OEM chrome liner w/ flange thickness 0.040 3) Used on build CE95231 4) Not used on build no CE95231 5) SN < UA38571D W/ SEDIMENT BOWL 6) 9" C-to-C

ENGINE INFORMATION

3.152

INDIRECT INJECTION ^ 3 CYL ROPE SEAL

BORE: 3.6020" 91.491mm



DESCRIPTION	PART NO.
MAJOR OH KIT	A-OK302
IN FRAME OH KIT	A-IK302

For Models: (35, 35 UTILITY, 50, 203, 205 ALL Eng SN 1935854>)

ENGINE COMPONENT PARTS

NOTICE: Parts included in the overhaul kits are indicated as follows:

M parts included in MAJOR OVERHAUL KITS

I parts included in IN FRAME OVERHAUL KITS



DESCRIPTION	PART NO	SIZE	QTY	KIT
Piston Liner Kit	A-U5MK0033		3	MI
Piston ¹	A-81512		3	
Liner, Cylinder (.150" Flange)	A-31358345		3	
Rings, Piston	A-41158057		3	



DESCRIPTION	PART NO	SIZE	QTY	KIT
Bearing Set, Main (4)	A-68084	STD	1	M
Bearing Set, Main (4)	A-68084A	.010	1	M
Bearing Set, Main (4)	A-68084B	.020	1	M
Bearing Set, Main (4)	A-68084C	.030	1	M



DESCRIPTION	PART NO	SIZE	QTY	KIT
Bearing Set, Conn Rod	A-85036	STD	1	MI
Bearing Set, Conn Rod	A-85036A	.010	1	MI
Bearing Set, Conn Rod	A-85036B	.020	1	MI
Bearing Set, Conn Rod	A-85036C	.030	1	MI



DESCRIPTION	PART NO	SIZE	QTY	KIT
Washer Set, Thrust (4)	A-31137211/21	STD	1	M
Washer Set, Thrust (4)	A-735800M1	.007	1	M
Washer, Thrust	A-TWK152		1	



DESCRIPTION	PART NO	SIZE	QTY	KIT
Seal, Front Crankshaft	A-2415344		1	M
Seal, Rear Crankshaft	A-36883106		2	M
Crankshaft	A-ZZ90116		1	



DESCRIPTION	PART NO	SIZE	QTY	KIT
Valve Train Kit	A-VTK301		1	M
Valve, Intake	A-31431261		3	
Valve, Exhaust	A-0910002		3	
Guide, Intake & Exhaust Valve	A-33261723		6	
Spring, Valve Outer	A-0780006		6	
Lock, Valve	A-0230001		6	



DESCRIPTION	PART NO	SIZE	QTY	KIT
Bushing, Conn Rod	A-31134151		3	M
Bolt, Conn Rod	A-0095250		6	MI
Nut, Conn Rod	A-33221327		6	MI
Connecting Rod ^{2,5}	A-ZZ90011		3	



DESCRIPTION	PART NO	SIZE	QTY	KIT
Gasket, Upper Set	A-U5LT0012		1	MI
Gasket, Lower Set w/o Seal	A-U5LB0012		1	MI
Gasket, Head	A-36812136		1	



DESCRIPTION	PART NO	SIZE	QTY	KIT
Camshaft	A-31415261		1	
Tappet	A-0860012		6	
Shaft, Rocker	A-ZZ90047		1	
Rocker Arm, LH	A-3737A101		3	
Arm, RH Rocker	A-3737A091		3	



DESCRIPTION	PART NO	SIZE	QTY	KIT
Gear, Crankshaft ³	A-0410132		1	
Gear, Camshaft Timing	A-731203M1		1	
Idler Gear, Camshaft	A-731205M2		1	



DESCRIPTION	PART NO	SIZE	QTY	KIT
Pump, Oil	A-41314078		1	
Pump, Fuel Lift ⁴	A-2641408		1	



DESCRIPTION	PART NO	SIZE	QTY	KIT
Assembly Lube; 8oz	A-10152		1	
Assembly lube; Case of 12-8oz bottles	A-10153		1	

Parts are not original equipment parts and are not sponsored, affiliated, or otherwise connected with any major brand.

ALLIS CHALMERS
CASE-IH
CATERPILLAR
CLARK
DEUTZ
FIAT
FORD / NEW HOLLAND
GEHL
HYSTER
IMT
INGERSOLL RAND
JACOBSEN
JCB
JOHN DEERE
LANDINI
LEYLAND
LINCOLN ELECTRIC
MASSEY FERGUSON
MELROE
MICHIGAN
OWATTONA
PERKINS USA
RENAULT
SULAIR CORP
VERMEER
WHITE/ OLIVER
ZETOR

1) flat head piston 2) Used on build CE95231 3) Not used on build no CE95231 4) SN < UA38571D W/ SEDIMENT BOWL 5) 9" C-to-C

D3.152

ENGINE INFORMATION

D3.152

DIRECT INJECTION ^ 3 CYL ROPE SEAL

BORE: 3.6020" 91.491mm



DESCRIPTION	PART NO.
ENG O/H KIT, MAJOR D3.152	A-OK303
IN FRAME OH KIT	A-IK303























For Models: (20, 40, 135, 150, 203, 205, 230, 235, 2135 ALL W/ E-SN ENDING IN D), (CRAWLER: (200, 2244 ALL W/ E-SN ENDING IN D)), (FORKLIFT: (2200, 2500 ALL W/ E-SN ENDING IN D))

ENGINE COMPONENT PARTS

NOTICE: Parts included in the overhaul kits are indicated as follows:

M parts included in MAJOR OVERHAUL KITS

I parts included in IN FRAME OVERHAUL KITS

DESCRIPTION	PART NO	SIZE	QTY	KIT
 Piston Liner Kit	A-U5MK0034		3	MI
 Piston	A-68332		3	
 Liner, Cylinder (.150" Flange)	A-31358345		3	
 Rings, Piston	A-41158057		3	
DESCRIPTION	PART NO	SIZE	QTY	KIT
 Bearing Set, Main (4)	A-68084	STD	1	M
 Bearing Set, Main (4)	A-68084A	.010	1	M
 Bearing Set, Main (4)	A-68084B	.020	1	M
 Bearing Set, Main (4)	A-68084C	.030	1	M
DESCRIPTION	PART NO	SIZE	QTY	KIT
 Bearing Set, Conn Rod	A-85036	STD	1	MI
 Bearing Set, Conn Rod	A-85036A	.010	1	MI
 Bearing Set, Conn Rod	A-85036B	.020	1	MI
 Bearing Set, Conn Rod	A-85036C	.030	1	MI
DESCRIPTION	PART NO	SIZE	QTY	KIT
 Washer Set, Thrust (4)	A-31137211/21	STD	1	M
 Washer Set, Thrust (4)	A-735800M1	.007	1	M
 Washer, Thrust	A-TWK152		1	
DESCRIPTION	PART NO	SIZE	QTY	KIT
 Seal, Front Crankshaft	A-2415344		1	M
 Seal, Rear Crankshaft	A-36883106		2	M
 Crankshaft	A-ZZ90116		1	
DESCRIPTION	PART NO	SIZE	QTY	KIT
 Valve Train Kit	A-VTK302		1	M
 Valve, Intake ^{1,2}	A-31431281		3	
 Valve, Exhaust ^{1,2}	A-31431591		3	
 Guide, Intake & Exhaust Valve	A-33261723		6	
 Spring, Valve Outer	A-0780006		6	
 Lock, Valve	A-0230001		6	



DESCRIPTION	PART NO	SIZE	QTY	KIT
Bushing, Conn Rod	A-31134151		3	M
Bolt, Conn Rod	A-0095250		6	MI
Nut, Conn Rod	A-33221327		6	MI
Connecting Rod ^{3,7}	A-ZZ90010		3	

DESCRIPTION	PART NO	SIZE	QTY	KIT
Gasket, Upper Set	A-U5LT0038		1	MI
Gasket, Lower Set w/o Seal	A-U5LB0012		1	MI
Gasket, Head	A-3681E006		1	

DESCRIPTION	PART NO	SIZE	QTY	KIT
Bearing, Camshaft	A-31134128		1	M
Camshaft	A-31415261		1	
Tappet	A-0860012		6	
Shaft, Rocker	A-ZZ90047		1	
Rocker Arm, LH	A-3737A101		3	
Arm, RH Rocker	A-3737A091		3	

DESCRIPTION	PART NO	SIZE	QTY	KIT
Gear, Crankshaft ⁴	A-0410132		1	
Gear, Camshaft Timing	A-731203M1		1	
Idler Gear, Camshaft	A-731205M2		1	

DESCRIPTION	PART NO	SIZE	QTY	KIT
Pump, Oil	A-41314078		1	
Pump, Fuel Lift ⁵	A-2641408		1	
Pump, Fuel Lift (2 Hole Mount) ⁶	A-3637307M1		1	

DESCRIPTION	PART NO	SIZE	QTY	KIT
Assembly Lube; 8oz	A-10152		1	
Assembly lube; Case of 12-8oz bottles	A-10153		1	

Parts are not original equipment parts and are not sponsored, affiliated, or otherwise connected with any major brand.

1) w/ 45 degree angle 2) 45 degree, w/ ZZ80082 Cylinder Head 3) Used on build CE95231 4) Not used on build no CE95231 5) SN < UA38571D W/ SEDIMENT BOWL 6) SN UA38572D> 7) 8.875" C-to-C

D3.152

ENGINE INFORMATION

D3.152

DIRECT INJECTION ^ 3 CYL LIP SEAL

BORE: 3.6020" 91.491mm

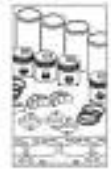

DESCRIPTION	PART NO.
MAJOR OH KIT	A-OK304
IN FRAME OH KIT	A-IK304

For Models: (INDUSTRIAL/CONSTRUCTION: 20, 40), (TRACTOR: 135, 230, 235 ALL ENG SN ENDING IN DL)

ENGINE COMPONENT PARTS

NOTICE: Parts included in the overhaul kits are indicated as follows:

M parts included in MAJOR OVERHAUL KITS

I parts included in IN FRAME OVERHAUL KITS

DESCRIPTION	PART NO	SIZE	QTY	KIT
Piston Liner Kit	A-U5MK0034		3	MI
Piston	A-68332		3	
Liner, Cylinder (.150" Flange)	A-31358345		3	
Rings, Piston	A-41158057		3	



DESCRIPTION	PART NO	SIZE	QTY	KIT
Bearing Set, Main (4)	A-68084	STD	1	M
Bearing Set, Main (4)	A-68084A	.010	1	M
Bearing Set, Main (4)	A-68084B	.020	1	M
Bearing Set, Main (4)	A-68084C	.030	1	M



DESCRIPTION	PART NO	SIZE	QTY	KIT
Bearing Set, Conn Rod	A-85036	STD	1	MI
Bearing Set, Conn Rod	A-85036A	.010	1	MI
Bearing Set, Conn Rod	A-85036B	.020	1	MI
Bearing Set, Conn Rod	A-85036C	.030	1	MI



DESCRIPTION	PART NO	SIZE	QTY	KIT
Washer Set, Thrust (4)	A-31137211/21	STD	1	M
Washer Set, Thrust (4)	A-735800M1	.007	1	M
Washer, Thrust	A-TWK152		1	



DESCRIPTION	PART NO	SIZE	QTY	KIT
Seal, Front Crankshaft	A-2415344		1	M
Seal, Rear Crankshaft	A-303158411		1	M
Crankshaft ¹	A-3637410M91		1	



DESCRIPTION	PART NO	SIZE	QTY	KIT
Valve Train Kit	A-VTK303		1	M
Valve, Intake ²	A-31431681		3	
Valve, Exhaust ^{2,3}	A-31431011		3	
Guide, Intake & Exhaust Valve	A-33261723		6	
Spring, Valve Outer	A-0780006		6	
Lock, Valve	A-0230001		6	



DESCRIPTION	PART NO	SIZE	QTY	KIT
Bushing, Conn Rod	A-31134151		3	M
Bolt, Conn Rod	A-0095250		6	MI
Nut, Conn Rod	A-33221327		6	MI
Connecting Rod ^{1,9}	A-ZZ90010		3	

ALLIS CHALMERS

CASE-IH

CATERPILLAR



DESCRIPTION	PART NO	SIZE	QTY	KIT
Gasket, Upper Set	A-U5LT0038		1	MI
Gasket, Lower Set w/o Seal	A-U5LB0011		1	MI
Gasket, Head	A-3681E006		1	

CLARK

DEUTZ

FIAT



DESCRIPTION	PART NO	SIZE	QTY	KIT
Bearing, Camshaft	A-31134128		1	M
Camshaft	A-31415261		1	
Tappet	A-0860012		6	
Shaft, Rocker	A-ZZ90047		1	
Rocker Arm, LH	A-3737A101		3	
Arm, RH Rocker	A-3737A091		3	

FORD / NEW HOLLAND

GEHL

HYSTER

DESCRIPTION	PART NO	SIZE	QTY	KIT
Gear, Crankshaft ⁴	A-0410132		1	
Gear, Camshaft Timing	A-731203M1		1	
Idler Gear, Camshaft	A-731205M2		1	



IMT

INGERSOLL RAND

DESCRIPTION	PART NO	SIZE	QTY	KIT
Pump, Oil	A-41314078		1	
Pump, Fuel Lift (4 Hole Mount) ^{5,6}	A-2641808		1	
Pump, Fuel Lift (2 Hole Mount) ^{7,8}	A-3637307M1		1	



JACOBSEN

JCB

DESCRIPTION	PART NO	SIZE	QTY	KIT
Assembly Lube; 8oz	A-10152		1	
Assembly lube; Case of 12-8oz bottles	A-10153		1	



JOHN DEERE

LANDINI

LEYLAND

LINCOLN ELECTRIC

MASSEY FERGUSON

MELROE

MICHIGAN

OWATTONA

PERKINS USA

RENAULT

SULAIR CORP

VERMEER

WHITE/OLIVER

ZETOR

Parts are not original equipment parts and are not sponsored, affiliated, or otherwise connected with any major brand.

1) Used on build CE95231 2) 30° w/ 68128 Cylinder Head 3) w/ 30 degree angle 4) Not used on build no CE95231 5) Eng SN <152UA535849G 6) Eng SN U635849>, 4 Hole 7) eng SN <UA6355849G, 2 hole 8) eng SN <U635848, 2 hole 9) 8.875" C-to-C

D3.152

ENGINE INFORMATION

D3.152

DIRECT INJECTION ^ 3 CYL, ROPE SEAL

BORE: 3.6020" 91.491mm



DESCRIPTION	PART NO.
MAJOR OH KIT	A-OK305
IN FRAME OH KIT	A-1K305

For Models: (TRACTOR: (235, 245 ALL ENG SN ENDING IN DS)), (INDUSTRIAL/ CONSTRUCTION: (20C, 30B ALL ENG SN ENDING IN DS))

ENGINE COMPONENT PARTS

NOTICE: Parts included in the overhaul kits are indicated as follows:

M parts included in MAJOR OVERHAUL KITS

I parts included in IN FRAME OVERHAUL KITS

DESCRIPTION	PART NO.	SIZE	QTY	KIT
Piston Liner Kit	A-U5MK0117		3	MI
Piston	A-89214		3	
Liner, Cylinder (.150" Flange)	A-31358345		3	
Rings, Piston	A-41158065		3	
DESCRIPTION	PART NO.	SIZE	QTY	KIT
Bearing Set, Main (4)	A-68084	STD	1	M
Bearing Set, Main (4)	A-68084A	.010	1	M
Bearing Set, Main (4)	A-68084B	.020	1	M
Bearing Set, Main (4)	A-68084C	.030	1	M
DESCRIPTION	PART NO.	SIZE	QTY	KIT
Bearing Set, Conn Rod	A-85036	STD	1	MI
Bearing Set, Conn Rod	A-85036A	.010	1	MI
Bearing Set, Conn Rod	A-85036B	.020	1	MI
Bearing Set, Conn Rod	A-85036C	.030	1	MI
DESCRIPTION	PART NO.	SIZE	QTY	KIT
Washer Set, Thrust (4)	A-31137211/21	STD	1	M
Washer Set, Thrust (4)	A-735800M1	.007	1	M
Washer, Thrust	A-TWK152		1	
DESCRIPTION	PART NO.	SIZE	QTY	KIT
Seal, Front Crankshaft	A-2415344		1	M
Seal, Rear Crankshaft	A-36883106		2	M
Crankshaft	A-ZZ90116		1	
DESCRIPTION	PART NO.	SIZE	QTY	KIT
Valve Train Kit	A-VTK303		1	M
Valve, Intake ¹	A-31431681		3	
Valve, Exhaust ^{1,2}	A-31431011		3	
Guide, Intake & Exhaust Valve	A-33261723		6	
Spring, Valve Outer	A-0780006		6	
Lock, Valve	A-0230001		6	



DESCRIPTION	PART NO.	SIZE	QTY	KIT
Bushing, Conn Rod	A-31134151		3	M
Bolt, Conn Rod	A-0095250		6	MI
Nut, Conn Rod	A-33221327		6	MI
Connecting Rod ¹¹	A-ZZ90010		3	

DESCRIPTION	PART NO.	SIZE	QTY	KIT
Gasket, Upper Set	A-U5LT0038		1	MI
Gasket, Lower Set w/o Sea	A-U5LB0012		1	MI
Gasket, Head	A-3681E006		1	

DESCRIPTION	PART NO.	SIZE	QTY	KIT
Bearing, Camshaft	A-31134128		1	M
Camshaft	A-31415261		1	
Tappet	A-0860012		6	
Shaft, Rocker	A-ZZ90047		1	
Rocker Arm, LH	A-3737A101		3	
Arm, RH Rocker	A-3737A091		3	

DESCRIPTION	PART NO.	SIZE	QTY	KIT
Gear, Crankshaft ³	A-0410132		1	
Gear, Camshaft Timing	A-731203M1		1	
Idler Gear, Camshaft	A-731205M2		1	

DESCRIPTION	PART NO.	SIZE	QTY	KIT
Pump, Oil	A-41314078		1	
Pump, Fuel Lift (4 Hole Mount) ^{4,5,6}	A-2641808		1	
Pump, Fuel Lift (2 Hole Mount) ^{7,8,9,10}	A-3637307M1		1	

DESCRIPTION	PART NO.	SIZE	QTY	KIT
Assembly Lube; 8oz	A-10152		1	
Assembly lube; Case of 12-8oz bottles	A-10153		1	

Parts are not original equipment parts and are not sponsored, affiliated, or otherwise connected with any major brand.

1) 30° w/ 68128 Cylinder Head 2) w/ 30 degree angle 3) Not used on build no CE95231 4) Eng SN <152UA535849G 5) Eng SN UA6355850G>, 4 Hole 6) Eng SN U635849>, 4 Hole 7) eng SN <UA6355849G, 2 hole 8) eng SN 152UA635850G> 9) SN UA38572D> 10) eng SN <U635848, 2 hole 11) 8.875" C-to-C

A3.152 Gas

ENGINE INFORMATION

A3.152 Gas

3 CYL, ROPE SEAL

BORE: 3.6020" 91.491mm



DESCRIPTION	PART NO.
MAJOR OH KIT	A-OK308
IN FRAME OH KIT	A-IK308

For Models: (TRACTOR: 135, 150), (INDUSTRIAL/CONSTRUCTION: 20, 40), (FORKLIFT: 2500)

ENGINE COMPONENT PARTS

NOTICE: Parts included in the overhaul kits are indicated as follows:

M parts included in MAJOR OVERHAUL KITS

I parts included in IN FRAME OVERHAUL KITS

DESCRIPTION	PART NO	SIZE	QTY	KIT
Piston Liner Kit	A-CK154		3	MI
Piston	A-86723		3	
Liner, Cylinder (.150" Flange)	A-31358345		3	
Rings, Piston	A-41158012		3	



DESCRIPTION	PART NO	SIZE	QTY	KIT
Bearing Set, Main (4)	A-68084	STD	1	M
Bearing Set, Main (4)	A-68084A	.010	1	M
Bearing Set, Main (4)	A-68084B	.020	1	M
Bearing Set, Main (4)	A-68084C	.030	1	M



DESCRIPTION	PART NO	SIZE	QTY	KIT
Bearing Set, Conn Rod	A-85036	STD	1	MI
Bearing Set, Conn Rod	A-85036A	.010	1	MI
Bearing Set, Conn Rod	A-85036B	.020	1	MI
Bearing Set, Conn Rod	A-85036C	.030	1	MI



DESCRIPTION	PART NO	SIZE	QTY	KIT
Washer Set, Thrust (4)	A-31137211/21	STD	1	M
Washer Set, Thrust (4)	A-735800M1	.007	1	M
Washer, Thrust	A-TWK152		1	



DESCRIPTION	PART NO	SIZE	QTY	KIT
Seal, Front Crankshaft	A-2415344		1	M
Seal, Rear Crankshaft	A-36883106		2	M
Crankshaft	A-ZZ90116		1	



DESCRIPTION	PART NO	SIZE	QTY	KIT
Valve Train Kit	A-VTK304		1	M
Valve, Intake	A-31431741		3	
Valve, Exhaust	A-31431731		3	
Guide, Intake & Exhaust Valve	A-3313E011		6	
Spring, Valve Outer	A-0780006		6	
Lock, Valve	A-0230001		6	



DESCRIPTION	PART NO	SIZE	QTY	KIT
Bushing, Conn Rod	A-31134151		3	M
Bolt, Conn Rod	A-0095250		6	MI
Nut, Conn Rod	A-33221327		6	MI
Connecting Rod ^{1,2}	A-ZZ90011		3	

ALLIS CHALMERS

CASE-IH

CATERPILLAR



DESCRIPTION	PART NO	SIZE	QTY	KIT
Gasket, Upper Set	A-U5LT0037		1	MI
Gasket, Lower Set w/o Seal	A-U5LB0012		1	MI
Gasket, Head	A-3681E006		1	

CLARK

DEUTZ

FIAT



DESCRIPTION	PART NO	SIZE	QTY	KIT
Camshaft	A-31415261		1	
Tappet	A-0860012		6	
Shaft, Rocker	A-ZZ90047		1	
Rocker Arm, LH	A-3737A101		3	
Arm, RH Rocker	A-3737A091		3	

FORD / NEW HOLLAND

GEHL

DESCRIPTION	PART NO	SIZE	QTY	KIT
Gear, Crankshaft	A-0410132		1	
Gear, Camshaft Timing	A-731203M1		1	
Idler Gear, Camshaft	A-731205M2		1	

HYSTER

IMT



DESCRIPTION	PART NO	SIZE	QTY	KIT
Pump, Oil	A-41314078		1	

INGERSOLL RAND

JACOBSEN



DESCRIPTION	PART NO	SIZE	QTY	KIT
Assembly Lube; 8oz	A-10152		1	
Assembly lube; Case of 12-8oz bottles	A-10153		1	

JCB

JOHN DEERE



LANDINI

LEYLAND

LINCOLN ELECTRIC

MASSEY FERGUSON

MELROE

MICHIGAN

OWATTONA

PERKINS USA

RENAULT

SULAIR CORP

VERMEER

WHITE/OLIVER

ZETOR

Parts are not original equipment parts and are not sponsored, affiliated, or otherwise connected with any major brand.

1) Used on build CE95231 2) 9" C-to-C

D3.152 Diesel

ENGINE INFORMATION

D3.152 Diesel

DIRECT INJECTION ^ 3 CYL, LIP SEAL

BORE: 3.6020" 91.491mm



DESCRIPTION	PART NO.
MAJOR OH KIT	A-OK306
IN FRAME OH KIT	A-IK306

For Models: (TRACTOR: (235, 245, 250 ALL ENG SN ENDING IN DSL)), (INDUSTRIAL/CONSTRUCTION: (20C, 30B ALL ENG SN ENDING IN DSL))

ENGINE COMPONENT PARTS

NOTICE: Parts included in the overhaul kits are indicated as follows:

M parts included in MAJOR OVERHAUL KITS

I parts included in IN FRAME OVERHAUL KITS

DESCRIPTION	PART NO.	SIZE	QTY	KIT
Piston Liner Kit	A-U5MK0117		3	MI
Piston	A-89214		3	
Liner, Cylinder (.150" Flange)	A-31358345		3	
Rings, Piston	A-41158065		3	
DESCRIPTION	PART NO.	SIZE	QTY	KIT
Bearing Set, Main (4)	A-68084	STD	1	M
Bearing Set, Main (4)	A-68084A	.010	1	M
Bearing Set, Main (4)	A-68084B	.020	1	M
Bearing Set, Main (4)	A-68084C	.030	1	M
DESCRIPTION	PART NO.	SIZE	QTY	KIT
Bearing Set, Conn Rod	A-85036	STD	1	MI
Bearing Set, Conn Rod	A-85036A	.010	1	MI
Bearing Set, Conn Rod	A-85036B	.020	1	MI
Bearing Set, Conn Rod	A-85036C	.030	1	MI
DESCRIPTION	PART NO.	SIZE	QTY	KIT
Washer Set, Thrust (4)	A-31137211/21	STD	1	M
Washer Set, Thrust (4)	A-735800M1	.007	1	M
Washer, Thrust	A-TWK152		1	
DESCRIPTION	PART NO.	SIZE	QTY	KIT
Seal, Front Crankshaft	A-2415344		1	M
Seal, Rear Crankshaft	A-303158411		1	M
Crankshaft ¹	A-3637410M91		1	
DESCRIPTION	PART NO.	SIZE	QTY	KIT
Valve Train Kit	A-VTK303		1	M
Valve, Intake ²	A-31431681		3	
Valve, Exhaust ^{2,3}	A-31431011		3	
Guide, Intake & Exhaust Valve	A-33261723		6	
Spring, Valve Outer	A-0780006		6	
Lock, Valve	A-0230001		6	



DESCRIPTION	PART NO.	SIZE	QTY	KIT
Bushing, Conn Rod	A-31134151		3	M
Bolt, Conn Rod	A-0095250		6	MI
Nut, Conn Rod	A-33221327		6	MI
Connecting Rod ⁷	A-ZZ90010		3	

DESCRIPTION	PART NO.	SIZE	QTY	KIT
Gasket, Upper Set	A-U5LT0038		1	MI
Gasket, Lower Set w/o Seal	A-U5LB0011		1	MI
Gasket, Head	A-3681E006		1	

DESCRIPTION	PART NO.	SIZE	QTY	KIT
Bearing, Camshaft	A-31134128		1	M
Camshaft	A-31415261		1	
Tappet	A-0860012		6	
Shaft, Rocker	A-ZZ90047		1	
Rocker Arm, LH	A-3737A101		3	
Arm, RH Rocker	A-3737A091		3	

DESCRIPTION	PART NO.	SIZE	QTY	KIT
Gear, Crankshaft ⁴	A-0410132		1	
Gear, Camshaft Timing	A-731203M1		1	
Idler Gear, Camshaft	A-731205M2		1	

DESCRIPTION	PART NO.	SIZE	QTY	KIT
Pump, Oil	A-41314078		1	
Pump, Fuel Lift (4 hole) ⁶	A-2641808		1	
Pump, Fuel Lift (2 hole) ⁵	A-3637307M1		1	

DESCRIPTION	PART NO.	SIZE	QTY	KIT
Assembly Lube; 8oz	A-10152		1	
Assembly lube; Case of 12-8oz bottles	A-10153		1	

Parts are not original equipment parts and are not sponsored, affiliated, or otherwise connected with any major brand.

1) Used on build CE95231 2) 30° w/ 68128 Cylinder Head 3) w/ 30 degree angle 4) Not used on build no CE95231 5) Eng SN <152UA535849G 6) Eng SN U635849>, 4 Hole 7) 8.875" C-to-C

D3.152 Diesel

ENGINE INFORMATION

D3.152 Diesel

DIRECT INJECTION ^ 3 CYL, LIP SEAL

BORE: 3.6020" 91.491mm

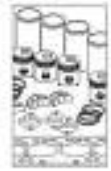

DESCRIPTION	PART NO.
MAJOR OVERHAUL KIT	A-OK3072
IN FRAME OH KIT	A-1K30712

For Models: (TRACTOR: 250)

ENGINE COMPONENT PARTS

NOTICE: Parts included in the overhaul kits are indicated as follows:

M parts included in MAJOR OVERHAUL KITS

I parts included in IN FRAME OVERHAUL KITS



DESCRIPTION	PART NO	SIZE	QTY	KIT
Piston Liner Kit	A-U5MK0034		3	MI
Piston	A-68332		3	
Liner, Cylinder (.150" Flange)	A-31358345		3	
Rings, Piston	A-41158057		3	



DESCRIPTION	PART NO	SIZE	QTY	KIT
Bearing Set, Main (4)	A-68084	STD	1	M
Bearing Set, Main (4)	A-68084A	.010	1	M
Bearing Set, Main (4)	A-68084B	.020	1	M
Bearing Set, Main (4)	A-68084C	.030	1	M



DESCRIPTION	PART NO	SIZE	QTY	KIT
Bearing Set, Conn Rod	A-85036	STD	1	MI
Bearing Set, Conn Rod	A-85036A	.010	1	MI
Bearing Set, Conn Rod	A-85036B	.020	1	MI
Bearing Set, Conn Rod	A-85036C	.030	1	MI



DESCRIPTION	PART NO	SIZE	QTY	KIT
Washer Set, Thrust (4)	A-31137211/21	STD	1	M
Washer, Thrust	A-TWK152		1	



DESCRIPTION	PART NO	SIZE	QTY	KIT
Seal, Front Crankshaft	A-2415344		1	M
Seal, Rear Crankshaft	A-303158411		1	M
Crankshaft ¹	A-3637410M91		1	



DESCRIPTION	PART NO	SIZE	QTY	KIT
Valve Train Kit ²	A-VTK302		1	M
Valve Train Kit ³	A-VTK303		1	M
Valve, Intake ²	A-31431281		3	
Valve, Intake ³	A-31431681		3	
Valve, Exhaust ²	A-31431591		3	
Valve, Exhaust ³	A-31431011		3	
Guide, Intake & Exhaust Valve	A-33261723		6	
Spring, Valve Outer	A-0780006		6	
Lock, Valve	A-0230001		1	



DESCRIPTION	PART NO	SIZE	QTY	KIT
Bushing, Conn Rod	A-31134151		3	M
Bolt, Conn Rod	A-0095250		6	MI
Nut, Conn Rod	A-33221327		6	MI
Connecting Rod ⁷	A-ZZ90010		3	



DESCRIPTION	PART NO	SIZE	QTY	KIT
Gasket, Upper Set	A-U5LT0038		1	MI
Gasket, Lower Set w/o Seal	A-U5LB0011		1	MI
Gasket, Head	A-3681E006		1	



DESCRIPTION	PART NO	SIZE	QTY	KIT
Bearing, Camshaft	A-31134128		1	M
Bearing, Camshaft	A-31134128		1	
Camshaft	A-31415261		1	
Tappet	A-0860012		6	
Shaft, Rocker	A-ZZ90047		1	
Rocker Arm, LH	A-3737A101		3	
Arm, RH Rocker	A-3737A091		3	



DESCRIPTION	PART NO	SIZE	QTY	KIT
Gear, Crankshaft ⁴	A-0410132		1	
Gear, Camshaft Timing	A-731203M1		1	
Idler Gear, Camshaft	A-731205M2		1	



DESCRIPTION	PART NO	SIZE	QTY	KIT
Pump, Oil	A-41314078		1	
Pump, Fuel Lift (4 Hole Mount) ⁵	A-2641808		1	
Pump, Fuel Lift (2 Hole Mount) ⁴	A-3637307M1		1	



DESCRIPTION	PART NO	SIZE	QTY	KIT
Assembly Lube; 8oz	A-10152		1	
Assembly lube; Case of 12-8oz bottles	A-10153		1	

Parts are not original equipment parts and are not sponsored, affiliated, or otherwise connected with any major brand.

ALLIS CHALMERS
CASE-IH
CATERPILLAR
CLARK
DEUTZ
FIAT
FORD / NEW HOLLAND
GEHL
HYSTER
IMT
INGERSOLL RAND
JACOBSEN
JCB
JOHN DEERE
LANDINI
LEYLAND
LINCOLN ELECTRIC
MASSEY FERGUSON
MELROE
MICHIGAN
OWATTONA
PERKINS USA
RENAULT
SULAIR CORP
VERMEER
WHITE/OLIVER
ZETOR

1) Used on build CE95231 2) 45°, w/ ZZ80082 Cylinder Head 3) 35° w/ 68128 Cylinder Head 4) Not used on build no CE95231 5) Eng SN U635849>, 4 Hole 6) eng SN <U635848, 2 hole 7) 8.875" C-to-C

4.203 Diesel

ENGINE INFORMATION

4.203 Diesel

INDIRECT INJECTION ^ 4 CYL, ROPE SEAL

BORE: 3.6020" 91.491mm



DESCRIPTION	PART NO.
MAJOR OH KIT	A-OK430
IN FRAME OH KIT	A-IK430

For Models: (TRACTOR: 65 E-SN <2820092), (INDUSTRIAL/CONSTRUCTION: 356 E-SN <2820092)

ENGINE COMPONENT PARTS

NOTICE: Parts included in the overhaul kits are indicated as follows:

M parts included in MAJOR OVERHAUL KITS

I parts included in IN FRAME OVERHAUL KITS

DESCRIPTION	PART NO	SIZE	QTY	KIT
Piston Liner Kit	A-CK152		4	MI
Piston ¹	A-81512		4	
Liner, Cylinder (.040" Flange) ²	A-31358308		4	
Rings, Piston	A-41158058		4	
DESCRIPTION	PART NO	SIZE	QTY	KIT
Bearing Set, Main (5)	A-68082	STD	1	M
Bearing Set, Main (5)	A-68082A	.010	1	M
Bearing Set, Main (5)	A-68082B	.020	1	M
Bearing Set, Main (5)	A-68082C	.030	1	M
DESCRIPTION	PART NO	SIZE	QTY	KIT
Bearing Set, Conn Rod	A-85035	STD	1	MI
Bearing Set, Conn Rod	A-85035A	.010	1	MI
Bearing Set, Conn Rod	A-85035B	.020	1	MI
Bearing Set, Conn Rod	A-85035C	.030	1	MI
DESCRIPTION	PART NO	SIZE	QTY	KIT
Washer Set, Thrust (4)	A-31137211/21	STD	1	M
Washer Set, Thrust (4)	A-735800M1	.007	1	M
Washer, Thrust	A-TWK152		1	
DESCRIPTION	PART NO	SIZE	QTY	KIT
Seal, Front Crankshaft	A-2415344		1	M
Seal, Rear Crankshaft ³	A-36883106		2	M
Crankshaft, Keyed Nose, Rope Seal ³	A-31315148		1	
DESCRIPTION	PART NO	SIZE	QTY	KIT
Valve Train Kit	A-VTK404		1	M
Valve, Intake	A-31431261		4	
Valve, Exhaust	A-0910002		4	
Guide, Intake & Exhaust Valve	A-33261723		8	
Spring, Valve Inner	A-0780007		8	
Spring, Valve Outer	A-0780006		8	
Lock, Valve	A-0230001		8	



DESCRIPTION	PART NO	SIZE	QTY	KIT
Bushing, Conn Rod	A-31134151		4	M
Bolt, Conn Rod	A-0095250		8	MI
Nut, Conn Rod	A-33221327		8	MI
Connecting Rod ^{4,6}	A-ZZ90011		4	

DESCRIPTION	PART NO	SIZE	QTY	KIT
Gasket, Upper Set	A-69036		1	MI
Gasket, Lower Set	A-U5LB0500		1	MI
Gasket, Head	A-36812125		1	

DESCRIPTION	PART NO	SIZE	QTY	KIT
Bearing, Camshaft	A-31134119		1	M

DESCRIPTION	PART NO	SIZE	QTY	KIT
Gear, Crankshaft	A-0410228		1	

DESCRIPTION	PART NO	SIZE	QTY	KIT
Pump, Oil	A-41314164		1	
Pump, Fuel Lift Transfer ⁵	A-3637338M91		1	

DESCRIPTION	PART NO	SIZE	QTY	KIT
Assembly Lube; 8oz	A-10152		1	
Assembly lube; Case of 12-8oz bottles	A-10153		1	

Parts are not original equipment parts and are not sponsored, affiliated, or otherwise connected with any major brand.

1) flat head piston 2) cast sleeve replaces OEM chrome liner w/ flange thickness 0.040 3) rope seal 4) Used on build CE95231 5) Use on build no. JD22028 6) 9" C-to-C

4.203 Diesel

ENGINE INFORMATION

4.203 Diesel

INDIRECT INJECTION ^ 4 CYL, ROPE SEAL

BORE: 3.6020" 91.491mm



DESCRIPTION	PART NO.
MAJOR OH KIT	A-OK431
IN FRAME OH KIT	A-IK431

For Models: (TRACTOR: 65 E-SN 2820092>), (INDUSTRIAL/CONSTRUCTION: 356 E-SN 2820092>)

ENGINE COMPONENT PARTS

NOTICE: Parts included in the overhaul kits are indicated as follows:

M parts included in MAJOR OVERHAUL KITS

I parts included in IN FRAME OVERHAUL KITS

DESCRIPTION	PART NO	SIZE	QTY	KIT
Piston Liner Kit	A-U5MK0033		4	MI
Piston ¹	A-81512		4	
Liner, Cylinder (.150" Flange)	A-31358345		4	
Rings, Piston	A-41158057		4	



DESCRIPTION	PART NO	SIZE	QTY	KIT
Bearing Set, Main (5)	A-68082	STD	1	M
Bearing Set, Main (5)	A-68082A	.010	1	M
Bearing Set, Main (5)	A-68082B	.020	1	M
Bearing Set, Main (5)	A-68082C	.030	1	M



DESCRIPTION	PART NO	SIZE	QTY	KIT
Bearing Set, Conn Rod	A-85035	STD	1	MI
Bearing Set, Conn Rod	A-85035A	.010	1	MI
Bearing Set, Conn Rod	A-85035B	.020	1	MI
Bearing Set, Conn Rod	A-85035C	.030	1	MI



DESCRIPTION	PART NO	SIZE	QTY	KIT
Washer Set, Thrust (4)	A-31137211/21	STD	1	M
Washer Set, Thrust (4)	A-735800M1	.007	1	M
Washer, Thrust	A-TWK152		1	



DESCRIPTION	PART NO	SIZE	QTY	KIT
Seal, Front Crankshaft	A-2415344		1	M
Seal, Rear Crankshaft ³	A-36883106		2	M
Crankshaft, Keyed Nose, Rope Seal ²	A-31315148		1	



DESCRIPTION	PART NO	SIZE	QTY	KIT
Valve Train Kit	A-VTK404		1	M
Valve, Intake	A-31431261		4	
Valve, Exhaust	A-0910002		4	
Guide, Intake & Exhaust Valve	A-33261723		8	
Spring, Valve Inner	A-0780007		8	
Spring, Valve Outer	A-0780006		8	
Lock, Valve	A-0230001		8	



DESCRIPTION	PART NO	SIZE	QTY	KIT
Bushing, Conn Rod	A-31134151		4	M
Bolt, Conn Rod	A-0095250		8	MI
Nut, Conn Rod	A-33221327		8	MI
Connecting Rod ^{3,4}	A-ZZ90011		4	

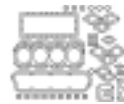

DESCRIPTION	PART NO	SIZE	QTY	KIT
Gasket, Upper Set	A-69036		1	MI
Gasket, Lower Set	A-U5LB0500		1	MI
Gasket, Head	A-36812125		1	



DESCRIPTION	PART NO	SIZE	QTY	KIT
Bearing, Camshaft	A-31134119		1	M



DESCRIPTION	PART NO	SIZE	QTY	KIT
Gear, Crankshaft	A-0410228		1	



DESCRIPTION	PART NO	SIZE	QTY	KIT
Pump, Oil	A-41314164		1	
Pump, Fuel Lift Transfer	A-3637338M91		1	



DESCRIPTION	PART NO	SIZE	QTY	KIT
Assembly Lube; 8oz	A-10152		1	
Assembly lube; Case of 12-8oz bottles	A-10153		1	

Parts are not original equipment parts and are not sponsored, affiliated, or otherwise connected with any major brand.

ALLIS CHALMERS
CASE-IH
CATERPILLAR
CLARK
DEUTZ
FIAT
FORD / NEW HOLLAND
GEHL
HYSTER
IMT
INGERSOLL RAND
JACOBSEN
JCB
JOHN DEERE
LANDINI
LEYLAND
LINCOLN ELECTRIC
MASSEY FERGUSON
MELROE
MICHIGAN
OWATTONA
PERKINS USA
RENAULT
SULAIR CORP
VERMEER
WHITE/ OLIVER
ZETOR

1) flat head piston 2) rope seal 3) Used on build CE95231 4) 9" C-to-C

D4.203 Diesel

ENGINE INFORMATION

D4.203 Diesel

DIRECT INJECTION ^ 4 CYL, ROPE SEAL

BORE: 3.6020" 91.491mm



DESCRIPTION	PART NO.
MAJOR OH KIT	A-OK432
IN FRAME OH KIT	A-1K432

For Models: (INDUSTRIAL/CONSTRUCTION: 365 E-SN <2939035 NOT ENDING W/ DL), (TRACTOR: 65 E-SN <2939035 NOT ENDING W/ DL)

ENGINE COMPONENT PARTS

NOTICE: Parts included in the overhaul kits are indicated as follows:

M parts included in MAJOR OVERHAUL KITS

I parts included in IN FRAME OVERHAUL KITS

DESCRIPTION	PART NO.	SIZE	QTY	KIT
Piston Liner Kit	A-CK153		4	MI
Piston	A-68332		4	
Liner, Cylinder (.040" Flange) ¹	A-31358308		4	
Rings, Piston	A-41158057		4	

DESCRIPTION	PART NO.	SIZE	QTY	KIT
Bearing Set, Main (5)	A-68082	STD	1	M
Bearing Set, Main (5)	A-68082A	.010	1	M
Bearing Set, Main (5)	A-68082B	.020	1	M
Bearing Set, Main (5)	A-68082C	.030	1	M

DESCRIPTION	PART NO.	SIZE	QTY	KIT
Bearing Set, Conn Rod	A-85035	STD	1	MI
Bearing Set, Conn Rod	A-85035A	.010	1	MI
Bearing Set, Conn Rod	A-85035B	.020	1	MI
Bearing Set, Conn Rod	A-85035C	.030	1	MI

DESCRIPTION	PART NO.	SIZE	QTY	KIT
Washer Set, Thrust (4)	A-31137211/21	STD	1	M
Washer Set, Thrust (4)	A-735800M1	.007	1	M

DESCRIPTION	PART NO.	SIZE	QTY	KIT
Seal, Front Crankshaft	A-2415344		1	M
Seal, Rear Crankshaft	A-36883106		2	M
Crankshaft, Keyed Nose, Rope Seal ²	A-31315148		1	

DESCRIPTION	PART NO.	SIZE	QTY	KIT
Valve Train Kit	A-VTK405		1	M
Valve, Intake ^{3,4}	A-31431281		4	
Valve, Exhaust ^{3,4}	A-31431591		4	
Guide, Intake & Exhaust Valve	A-33261723		8	
Spring, Valve Inner	A-0780007		8	
Spring, Valve Outer	A-0780006		8	
Lock, Valve	A-0230001		8	



DESCRIPTION	PART NO.	SIZE	QTY	KIT
Bushing, Conn Rod	A-31134151		4	M
Bolt, Conn Rod	A-0095250		8	MI
Nut, Conn Rod	A-33221327		8	MI
Connecting Rod ⁵	A-ZZ90010		4	

DESCRIPTION	PART NO.	SIZE	QTY	KIT
Gasket, Upper Set	A-U5LT0069		1	MI
Gasket, Lower Set w/o Seal	A-82908		1	MI
Gasket Set	A-3A65FS		1	
Gasket, Head	A-36812138		1	

DESCRIPTION	PART NO.	SIZE	QTY	KIT
Tappet	A-0860012		8	
Rocker Arm, LH	A-3737A101		4	
Arm, RH Rocker	A-3737A091		4	

DESCRIPTION	PART NO.	SIZE	QTY	KIT
Bearing, Camshaft	A-31134119		1	M
Gear, Crankshaft	A-0410228		1	

DESCRIPTION	PART NO.	SIZE	QTY	KIT
Pump, Oil	A-41314164		1	
Pump, Fuel Lift Transfer	A-3637338M91		1	

DESCRIPTION	PART NO.	SIZE	QTY	KIT
Assembly Lube; 8oz	A-10152		1	
Assembly lube; Case of 12-8oz bottles	A-10153		1	

Parts are not original equipment parts and are not sponsored, affiliated, or otherwise connected with any major brand.

1) cast sleeve replaces OEM chrome liner w/ flange thickness 0.040 2) rope seal 3) w/ 45 degree angle 4) 45 degree, w/ ZZ80082 Cylinder Head 5) 8.875" C-to-C

D4.203 Diesel

ENGINE INFORMATION

D4.203 Diesel

DIRECT INJECTION 4 CYL, ROPE & LIP SEAL

BORE: 3.6020" 91.491mm



DESCRIPTION	PART NO.
MAJOR OH KIT	A-OK434
IN FRAME OH KIT	A-IK434

For Models: (65, 165, 255, 302, 304, 3165, 356 ALL E-SN 2939036-29C1084), 40B, 50, 30, (COMBINE: 300 E-SN 2939036-29C1084)

ENGINE COMPONENT PARTS

NOTICE: Parts included in the overhaul kits are indicated as follows:

M parts included in MAJOR OVERHAUL KITS

I parts included in IN FRAME OVERHAUL KITS

DESCRIPTION	PART NO	SIZE	QTY	KIT
Piston Liner Kit	A-U5MK0034		4	MI
Piston	A-68332		4	
Liner, Cylinder (.150" Flange)	A-31358345		4	
Rings, Piston	A-41158057		4	



DESCRIPTION	PART NO	SIZE	QTY	KIT
Bearing Set, Main (5)	A-68082	STD	1	M
Bearing Set, Main (5)	A-68082A	.010	1	M
Bearing Set, Main (5)	A-68082B	.020	1	M
Bearing Set, Main (5)	A-68082C	.030	1	M



DESCRIPTION	PART NO	SIZE	QTY	KIT
Bearing Set, Conn Rod	A-85035	STD	1	MI
Bearing Set, Conn Rod	A-85035A	.010	1	MI
Bearing Set, Conn Rod	A-85035B	.020	1	MI
Bearing Set, Conn Rod	A-85035C	.030	1	MI



DESCRIPTION	PART NO	SIZE	QTY	KIT
Washer Set, Thrust (4)	A-31137211/21	STD	1	M
Washer Set, Thrust (4)	A-735800M1	.007	1	M



DESCRIPTION	PART NO	SIZE	QTY	KIT
Seal, Front Crankshaft	A-2415344		1	M
Seal, Rear Crankshaft ¹	A-36883106		2	M
Seal, Rear Crankshaft ²	A-303158411		1	M
Crankshaft, Keyed Nose, Rope Seal ¹	A-31315148		1	
Crankshaft, Keyed Nose, Lip Seal ²	A-3637458M91		1	



DESCRIPTION	PART NO	SIZE	QTY	KIT
Valve Train Kit	A-VTK405		1	M
Valve, Intake ^{3,4}	A-31431281		4	
Valve, Exhaust ^{3,4}	A-31431591		4	
Guide, Intake & Exhaust Valve	A-33261723		8	
Spring, Valve Inner	A-0780007		8	
Spring, Valve Outer	A-0780006		8	
Lock, Valve	A-0230001		8	



DESCRIPTION	PART NO	SIZE	QTY	KIT
Bushing, Conn Rod	A-31134151		4	M
Bolt, Conn Rod	A-0095250		8	MI
Nut, Conn Rod	A-33221327		8	MI
Connecting Rod ⁵	A-ZZ90010		4	

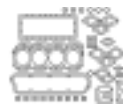

DESCRIPTION	PART NO	SIZE	QTY	KIT
Gasket, Upper Set	A-U5LT0069		1	MI
Gasket, Lower Set w/o Seal	A-68036		1	MI
Gasket, Lower Set w/o Seal	A-82908		1	MI
Gasket, Head	A-36812138		1	



DESCRIPTION	PART NO	SIZE	QTY	KIT
Tappet	A-0860012		8	
Rocker Arm, LH	A-3737A101		4	
Arm, RH Rocker	A-3737A091		4	



DESCRIPTION	PART NO	SIZE	QTY	KIT
Bearing, Camshaft	A-31134119		1	M
Gear, Crankshaft	A-0410228		1	



DESCRIPTION	PART NO	SIZE	QTY	KIT
Pump, Oil	A-41314164		1	
Pump, Fuel Lift Transfer	A-3637338M91		1	



DESCRIPTION	PART NO	SIZE	QTY	KIT
Assembly Lube; 8oz	A-10152		1	
Assembly lube; Case of 12-8oz bottles	A-10153		1	

Parts are not original equipment parts and are not sponsored, affiliated, or otherwise connected with any major brand.

ALLIS CHALMERS
CASE-IH
CATERPILLAR
CLARK
DEUTZ
FIAT
FORD / NEW HOLLAND
GEHL
HYSTER
IMT
INGERSOLL RAND
JACOBSEN
JCB
JOHN DEERE
LANDINI
LEYLAND
LINCOLN ELECTRIC
MASSEY FERGUSON
MELROE
MICHIGAN
OWATTONA
PERKINS USA
RENAULT
SULAIR CORP
VERMEER
WHITE/ OLIVER
ZETOR

1) rope seal 2) lip seal 3) w/ 45 degree angle 4) 45 degree, w/ ZZ80082 Cylinder Head 5) 8.875" C-to-C

4.212 Diesel

ENGINE INFORMATION

4.212 Diesel

4 CYL, ROPE & LIP SEAL

BORE: 3.8770" 98.476mm



DESCRIPTION	PART NO.
MAJOR OH KIT	A-0K506
IN FRAME OH KIT	A-1K506

For Models: (TRACTOR: 165 E-SN <UA187117L), (INDUSTRIAL/CONSTRUCTION: 50, 50B ALL E-SN <UA187117L))

ENGINE COMPONENT PARTS

NOTICE: Parts included in the overhaul kits are indicated as follows:

M parts included in MAJOR OVERHAUL KITS

I parts included in IN FRAME OVERHAUL KITS

DESCRIPTION	PART NO	SIZE	QTY	KIT
Piston Liner Kit	A-U5MK0066		4	MI
Piston	A-86721		4	
Liner, Cylinder	A-31358394		4	
Rings, Piston	A-41158044		4	

DESCRIPTION	PART NO	SIZE	QTY	KIT
Bearing Set, Main (5)	A-81558	STD	1	M
Bearing Set, Main (5)	A-81558A	.010	1	M
Bearing Set, Main (5)	A-81558B	.020	1	M
Bearing Set, Main (5)	A-81558C	.030	1	M

DESCRIPTION	PART NO	SIZE	QTY	KIT
Bearing Set, Conn Rod	A-85042	STD	1	MI
Bearing Set, Conn Rod	A-85042A	.010	1	MI
Bearing Set, Conn Rod	A-85042B	.020	1	MI
Bearing Set, Conn Rod	A-85042C	.030	1	MI

DESCRIPTION	PART NO	SIZE	QTY	KIT
Washer Set, Thrust (4)	A-31137551/61	STD	1	M

DESCRIPTION	PART NO	SIZE	QTY	KIT
Seal, Front Crankshaft	A-2418F436		1	M

DESCRIPTION	PART NO	SIZE	QTY	KIT
Seal, Rear Crankshaft ²	A-303158411		1	M

DESCRIPTION	PART NO	SIZE	QTY	KIT
Seal, Rear Crankshaft ¹	A-36883108		2	M

DESCRIPTION	PART NO	SIZE	QTY	KIT
Crankshaft Kit with Rope Seal	A-ZZ90100		1	

DESCRIPTION	PART NO	SIZE	QTY	KIT
Crankshaft Kit with Lip Seal	A-ZZ90077		1	



DESCRIPTION	PART NO	SIZE	QTY	KIT
Valve Train Kit	A-VTK406		1	M
Valve, Intake	A-31431641		4	
Valve, Exhaust	A-31431881		4	
Guide, Intake Valve	A-3343F002		4	
Guide, Exhaust Valve	A-3343J002		4	
Spring, Valve Inner	A-31744131		8	
Spring, Valve Outer	A-31745121		8	
Seal, Valve	A-33817117		8	
Keeper, Valve	A-33173108		8	



DESCRIPTION	PART NO	SIZE	QTY	KIT
Bushing, Conn Rod	A-31134123		4	M
Bolt, Conn Rod	A-4222485M1		8	MI
Nut, Conn Rod	A-33221328		8	MI
Connecting Rod	A-ZZ90009		4	

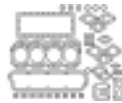

DESCRIPTION	PART NO	SIZE	QTY	KIT
Gasket, Upper Set	A-U5LT0015		1	MI
Gasket, Lower Set w/o Seal	A-U5LB0045		1	MI
Gasket, Head	A-36812349		1	
Gasket Set, Oil Pan	A-U5MK0600		1	



DESCRIPTION	PART NO	SIZE	QTY	KIT
Bearing, Camshaft	A-31134132		1	M
Camshaft ³	A-31415321		1	
Camshaft ⁴	A-736818M1		1	
Tappet	A-31434163		8	
Rod, Push	A-31434307		8	
Shaft, Rocker	A-ZZ90032		1	
Rocker Arm, LH	A-41151483		4	
Arm, RH Rocker	A-41151484		4	



DESCRIPTION	PART NO	SIZE	QTY	KIT
Gear, Crankshaft	A-31171681		1	
Gear, Idler ⁵	A-41115023		1	



DESCRIPTION	PART NO	SIZE	QTY	KIT
Pump, Oil ^{5,6}	A-3638631M91		1	
Pump, Fuel Lift Transfer	A-2641728		1	



DESCRIPTION	PART NO	SIZE	QTY	KIT
Assembly Lube; 8oz	A-10152		1	
Assembly lube; Case of 12-8oz bottles	A-10153		1	

Parts are not original equipment parts and are not sponsored, affiliated, or otherwise connected with any major brand.

1) Rope Seal 2) Lip Seal 3) eng SN <U106654N 4) eng SN U106655N> 5) check w/ build list 6) For Non Agricultural Use

4.236 Diesel

ENGINE INFORMATION

4.236 Diesel

4 CYL, ROPE SEAL

BORE: 3.8770" 98.476mm



DESCRIPTION	PART NO.
MAJOR OH KIT	A-OK445
IN FRAME OH KIT	A-IK445

For Models: (TRACTOR: (165, 255, 275 ALL E-SN <JA103063L)), (INDUSTRIAL/ CONSTRUCTION: (50C, 6000 ALL E-SN <JA1030631))

ENGINE COMPONENT PARTS

NOTICE: Parts included in the overhaul kits are indicated as follows:

M parts included in MAJOR OVERHAUL KITS

I parts included in IN FRAME OVERHAUL KITS

DESCRIPTION	PART NO	SIZE	QTY	KIT
Piston Liner Kit	A-U5MK0123		4	MI
Piston	A-68301		4	
Liner, Cylinder	A-31358394		4	
Rings, Piston	A-41158041		4	



DESCRIPTION	PART NO	SIZE	QTY	KIT
Bearing Set, Main (5)	A-81558	STD	1	M
Bearing Set, Main (5)	A-81558A	.010	1	M
Bearing Set, Main (5)	A-81558B	.020	1	M
Bearing Set, Main (5)	A-81558C	.030	1	M



DESCRIPTION	PART NO	SIZE	QTY	KIT
Bearing Set, Conn Rod	A-85042	STD	1	MI
Bearing Set, Conn Rod	A-85042A	.010	1	MI
Bearing Set, Conn Rod	A-85042B	.020	1	MI
Bearing Set, Conn Rod	A-85042C	.030	1	MI



DESCRIPTION	PART NO	SIZE	QTY	KIT
Washer Set, Thrust (4)	A-31137551/61	STD	1	M



DESCRIPTION	PART NO	SIZE	QTY	KIT
Seal, Front Crankshaft	A-2418F436		1	M
Seal, Rear Crankshaft	A-36883108		2	M
Crankshaft, Splined Nose, Rope Seal	A-31315884		1	



DESCRIPTION	PART NO	SIZE	QTY	KIT
Valve Train Kit	A-VTK406		1	M
Valve, Intake	A-31431641		4	
Valve, Exhaust	A-31431881		4	
Guide, Intake Valve	A-3343F002		4	
Guide, Exhaust Valve	A-3343J002		4	
Spring, Valve Inner	A-31744131		8	
Spring, Valve Outer	A-31745121		8	
Seal, Valve	A-33817117		8	
Keeper, Valve	A-33173108		12	



DESCRIPTION	PART NO	SIZE	QTY	KIT
Bushing, Conn Rod	A-31134123		4	M
Bolt, Conn Rod	A-4222485M1		8	MI
Nut, Conn Rod	A-33221328		8	MI
Connecting Rod	A-ZZ90009		4	

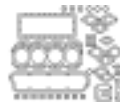

DESCRIPTION	PART NO	SIZE	QTY	KIT
Gasket, Upper Set	A-U5LT0015		1	MI
Gasket, Lower Set w/o Seal	A-U5LB0045		1	MI
Gasket, Head	A-36812349		1	
Gasket Set, Oil Pan	A-U5MK0600		1	
Gasket, Timing Cover	A-3681P045		1	



DESCRIPTION	PART NO	SIZE	QTY	KIT
Bearing, Camshaft	A-31134132		1	M
Camshaft	A-31415321		1	
Tappet	A-31434163		8	
Rod, Push	A-31434307		8	
Shaft, Rocker	A-ZZ90032		1	
Rocker Arm, LH	A-41151483		4	
Arm, RH Rocker	A-41151484		4	



DESCRIPTION	PART NO	SIZE	QTY	KIT
Gear, Crankshaft	A-31171681		1	
Gear, Idler	A-41115023		1	



DESCRIPTION	PART NO	SIZE	QTY	KIT
Pump, Oil ¹	A-3638631M91		1	
Pump, Fuel Lift ²	A-2641338		1	
Pump, Fuel Lift Transfer ³	A-2641728		1	



DESCRIPTION	PART NO	SIZE	QTY	KIT
Assembly Lube; 8oz	A-10152		1	
Assembly lube; Case of 12-8oz bottles	A-10153		1	

Parts are not original equipment parts and are not sponsored, affiliated, or otherwise connected with any major brand.

ALLIS CHALMERS
CASE-IH
CATERPILLAR
CLARK
DEUTZ
FIAT
FORD / NEW HOLLAND
GEHL
HYSTER
IMT
INGERSOLL RAND
JACOBSEN
JCB
JOHN DEERE
LANDINI
LEYLAND
LINCOLN ELECTRIC
MASSEY FERGUSON
MELROE
MICHIGAN
OWATTONA
PERKINS USA
RENAULT
SULAIR CORP
VERMEER
WHITE/ OLIVER
ZETOR

1) For Non Agricultural Use 2) eng SN <236UA57134 3) eng SN 236UA57135>

4.236 Diesel

ENGINE INFORMATION

4.236 Diesel

4 CYL, LIP SEAL

BORE: 3.8770" 98.476mm



DESCRIPTION	PART NO.
MAJOR OH KIT	A-0K507
IN FRAME OH KIT	A-1K507

For Models: (TRACTOR: (175, 255, 275 ALL E-SN UA103064L-U106654N)), (INDUSTRIAL/CONSTRUCTION: 50C E-SN UA103064L-U106654N)

ENGINE COMPONENT PARTS

NOTICE: Parts included in the overhaul kits are indicated as follows:

M parts included in MAJOR OVERHAUL KITS

I parts included in IN FRAME OVERHAUL KITS

DESCRIPTION	PART NO.	SIZE	QTY	KIT
Piston Liner Kit	A-U5MK0123		4	M
Piston	A-68301		4	
Liner, Cylinder	A-31358394		4	
Rings, Piston	A-41158041		4	

DESCRIPTION	PART NO.	SIZE	QTY	KIT
Bearing Set, Main (5)	A-81558	STD	1	M
Bearing Set, Main (5)	A-81558A	.010	1	M
Bearing Set, Main (5)	A-81558B	.020	1	M
Bearing Set, Main (5)	A-81558C	.030	1	M

DESCRIPTION	PART NO.	SIZE	QTY	KIT
Bearing Set, Conn Rod	A-85042	STD	1	M
Bearing Set, Conn Rod	A-85042A	.010	1	M
Bearing Set, Conn Rod	A-85042B	.020	1	M
Bearing Set, Conn Rod	A-85042C	.030	1	M

DESCRIPTION	PART NO.	SIZE	QTY	KIT
Washer Set, Thrust (4)	A-31137551/61	STD	1	M

DESCRIPTION	PART NO.	SIZE	QTY	KIT
Seal, Front Crankshaft	A-2418F436		1	M
Seal, Rear Crankshaft	A-303158411		1	M
Crankshaft ¹	A-3637401M91		1	

DESCRIPTION	PART NO.	SIZE	QTY	KIT
Valve Train Kit	A-VTK406		1	M
Valve, Intake	A-31431641		4	
Valve, Exhaust	A-31431881		4	
Guide, Intake Valve	A-3343F002		4	
Guide, Exhaust Valve	A-3343J002		4	
Spring, Valve Inner	A-31744131		8	
Spring, Valve Outer	A-31745121		8	
Keeper, Valve	A-33173108		8	
Seal, Valve	A-33817117		8	



DESCRIPTION	PART NO.	SIZE	QTY	KIT
Bushing, Conn Rod	A-31134123		4	M
Bolt, Conn Rod	A-4222485M1		8	M
Nut, Conn Rod	A-33221328		8	M
Connecting Rod	A-ZZ90009		4	



DESCRIPTION	PART NO.	SIZE	QTY	KIT
Gasket, Upper Set	A-U5LT0015		1	M
Gasket, Lower Set w/o Seal	A-U5LB0045		1	M
Gasket, Head	A-36812349		1	
Gasket Set, Oil Pan	A-U5MK0600		1	
Gasket, Timing Cover	A-3681P045		1	



DESCRIPTION	PART NO.	SIZE	QTY	KIT
Bearing, Camshaft	A-31134132		1	M
Camshaft	A-31415321		1	
Tappet	A-31434163		8	
Rod, Push	A-31434307		8	
Shaft, Rocker	A-ZZ90032		1	
Rocker Arm, LH	A-41151483		4	
Arm, RH Rocker	A-41151484		4	
Bushing, Rocker Shaft	A-2511425		8	



DESCRIPTION	PART NO.	SIZE	QTY	KIT
Gear, Crankshaft	A-311171681		1	
Gear, Idler ²	A-41115023		1	



DESCRIPTION	PART NO.	SIZE	QTY	KIT
Pump, Oil ³	A-3638631M91		1	
Pump, Fuel Lift Transfer ⁴	A-2641728		1	



DESCRIPTION	PART NO.	SIZE	QTY	KIT
Assembly Lube; 8oz	A-10152		1	
Assembly lube; Case of 12-8oz bottles	A-10153		1	

Parts are not original equipment parts and are not sponsored, affiliated, or otherwise connected with any major brand.

1) Splined Nose- 3 Bolt, Lip Seal 2) check w/ build list 3) For Non Agricultural Use 4) eng SN 236UA57135>

T4.236 Diesel

ENGINE INFORMATION

T4.236 Diesel

TURBOCHARGED, 4 CYL, LIP SEAL

BORE: 3.8770" 98.476mm



DESCRIPTION	PART NO.
MAJOR OH KIT	A-OK510
IN FRAME OH KIT	A-IK510

For Models: (TRACTOR: (698, 3065 ALL E-SN U106655N>)), ((UNDEFINED): 3370 E-SN U106655N>)

ENGINE COMPONENT PARTS

NOTICE: Parts included in the overhaul kits are indicated as follows:

M parts included in MAJOR OVERHAUL KITS

I parts included in IN FRAME OVERHAUL KITS

DESCRIPTION	PART NO	SIZE	QTY	KIT
Piston Liner Kit	A-CK236T		4	M
Piston	A-U5LP0022		4	
Liner, Cylinder	A-3135X032		4	
Rings, Piston	A-41158145		4	



DESCRIPTION	PART NO	SIZE	QTY	KIT
Bearing Set, Main (5)	A-81558	STD	1	M
Bearing Set, Main (5)	A-81558A	.010	1	M
Bearing Set, Main (5)	A-81558B	.020	1	M
Bearing Set, Main (5)	A-81558C	.030	1	M



DESCRIPTION	PART NO	SIZE	QTY	KIT
Bearing Set, Conn Rod	A-85042	STD	1	M
Bearing Set, Conn Rod	A-85042A	.010	1	M
Bearing Set, Conn Rod	A-85042B	.020	1	M
Bearing Set, Conn Rod	A-85042C	.030	1	M



DESCRIPTION	PART NO	SIZE	QTY	KIT
Washer Set, Thrust (4)	A-31137551/61	STD	1	M



DESCRIPTION	PART NO	SIZE	QTY	KIT
Seal, Front Crankshaft	A-2418F436		1	M
Seal, Rear Crankshaft	A-303158411		1	M
Crankshaft ¹	A-3637401M91		1	



DESCRIPTION	PART NO	SIZE	QTY	KIT
Valve Train Kit	A-VTK414		1	M
Valve, Intake	A-3142H002		4	
Valve, Exhaust	A-3142A052		4	
Guide, Intake Valve	A-3343F002		4	
Guide, Exhaust Valve	A-3343J002		4	
Spring, Valve Inner	A-31744131		8	
Spring, Valve Outer	A-31745121		8	
Seal, Valve	A-33817117		8	
Keeper, Valve	A-33173108		8	



DESCRIPTION	PART NO	SIZE	QTY	KIT
Bushing, Conn Rod	A-31134131		4	M
Bolt, Conn Rod	A-4222485M1		8	M
Nut, Conn Rod	A-33221328		8	M
Rod, Connecting (Turbo) ²	A-ZZ90013		4	

ALLIS CHALMERS

CASE-IH

CATERPILLAR

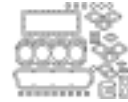

DESCRIPTION	PART NO	SIZE	QTY	KIT
Gasket, Upper Set	A-U5LT0046		1	M
Gasket, Lower Set w/o Seal	A-U5LB0045		1	M
Gasket, Head	A-3681E016		1	
Gasket Set, Oil Pan	A-U5MK0600		1	
Gasket, Timing Cover	A-3681P045		1	

CLARK

DEUTZ

FIAT

FORD / NEW HOLLAND



DESCRIPTION	PART NO	SIZE	QTY	KIT
Bearing, Camshaft	A-31134132		1	M
Tappet	A-31434163		8	
Rod, Push	A-31434307		8	
Shaft, Rocker	A-ZZ90032		1	
Rocker Arm, LH	A-41151483		4	
Arm, RH Rocker	A-41151484		4	
Bushing, Rocker Shaft	A-2511425		8	

GEHL

HYSTER

IMT

INGERSOLL RAND

DESCRIPTION	PART NO	SIZE	QTY	KIT
Gear, Crankshaft	A-31171681		1	

JACOBSEN

JCB



DESCRIPTION	PART NO	SIZE	QTY	KIT
Pump, Oil	A-4132F012		1	
Pump, Oil ³	A-4132F041		1	
Pump, Fuel Lift Transfer	A-2641728		1	

JOHN DEERE

LANDINI



DESCRIPTION	PART NO	SIZE	QTY	KIT
Assembly Lube; 8oz	A-10152		1	
Assembly lube; Case of 12-8oz bottles	A-10153		1	

LEYLAND

LINCOLN ELECTRIC



MASSEY FERGUSON

MELROE

MICHIGAN

OWATTONA

PERKINS USA

RENAULT

SULAIR CORP

VERMEER

WHITE/OLIVER

ZETOR

Parts are not original equipment parts and are not sponsored, affiliated, or otherwise connected with any major brand.

1) Splined Nose- 3 Bolt, Lip Seal 2) check w/ build list 3) for use on agricultural applications

4.248 Diesel

ENGINE INFORMATION

4.248 Diesel

4 CYL, ROPE SEAL

BORE: 3.9785" 101.054mm



DESCRIPTION	PART NO.
MAJOR OH KIT	A-0K460
IN FRAME OH KIT	A-1K460

For Models: (TRACTOR: 275 E-SN <248UA123423L)

ENGINE COMPONENT PARTS

NOTICE: Parts included in the overhaul kits are indicated as follows:

M parts included in MAJOR OVERHAUL KITS

I parts included in IN FRAME OVERHAUL KITS

DESCRIPTION	PART NO.	SIZE	QTY	KIT
Piston Liner Kit	A-U5MK0067		4	MI
Piston	A-89207		4	
Liner, Cylinder (Finished) 4.248 ¹	A-31358352		4	
Rings, Piston	A-4181A009		4	

DESCRIPTION	PART NO.	SIZE	QTY	KIT
Bearing Set, Main (5)	A-81558	STD	1	M
Bearing Set, Main (5)	A-81558A	.010	1	M
Bearing Set, Main (5)	A-81558B	.020	1	M
Bearing Set, Main (5)	A-81558C	.030	1	M

DESCRIPTION	PART NO.	SIZE	QTY	KIT
Bearing Set, Conn Rod	A-85042	STD	1	MI
Bearing Set, Conn Rod	A-85042A	.010	1	MI
Bearing Set, Conn Rod	A-85042B	.020	1	MI
Bearing Set, Conn Rod	A-85042C	.030	1	MI

DESCRIPTION	PART NO.	SIZE	QTY	KIT
Washer Set, Thrust (4)	A-31137551/61	STD	1	M

DESCRIPTION	PART NO.	SIZE	QTY	KIT
Seal, Front Crankshaft	A-2418F436		1	M
Seal, Rear Crankshaft	A-36883108		2	M
Crankshaft, Splined Nose, Rope Seal ²	A-31315884		1	

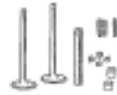

DESCRIPTION	PART NO.	SIZE	QTY	KIT
Valve Train Kit	A-VTK406		1	M
Valve, Intake	A-31431641		4	
Valve, Exhaust	A-31431881		4	
Guide, Intake Valve	A-3343F002		4	
Guide, Exhaust Valve	A-3343J002		4	
Spring, Valve Inner	A-31744131		8	
Spring, Valve Outer	A-31745121		8	
Keeper, Valve	A-33173108		8	
Seal, Valve	A-33817117		8	



DESCRIPTION	PART NO.	SIZE	QTY	KIT
Bushing, Conn Rod	A-31134123		4	M
Bolt, Conn Rod	A-4222485M1		8	MI
Nut, Conn Rod	A-33221328		8	MI
Connecting Rod	A-ZZ90009		4	

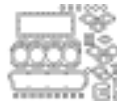

DESCRIPTION	PART NO.	SIZE	QTY	KIT
Gasket, Upper Set	A-U5LT0015		1	MI
Gasket, Lower Set w/o Seal	A-U5LB0045		1	MI
Gasket, Head	A-36812349		1	
Gasket Set, Oil Pan	A-U5MK0600		1	



DESCRIPTION	PART NO.	SIZE	QTY	KIT
Bearing, Camshaft	A-31134132		1	M
Camshaft	A-31415321		1	
Tappet	A-31434163		8	
Rod, Push	A-31434307		8	
Shaft, Rocker	A-ZZ90032		1	
Rocker Arm, LH	A-41151483		4	
Arm, RH Rocker	A-41151484		4	
Bushing, Rocker Shaft	A-2511425		8	



DESCRIPTION	PART NO.	SIZE	QTY	KIT
Gear, Crankshaft	A-31171681		1	
Gear, Camshaft	A-31171353		1	
Gear, Idler	A-41115023		1	



DESCRIPTION	PART NO.	SIZE	QTY	KIT
Pump, Fuel Lift Transfer	A-2641728		1	



DESCRIPTION	PART NO.	SIZE	QTY	KIT
Assembly Lube; 8oz	A-10152		1	
Assembly lube; Case of 12-8oz bottles	A-10153		1	

Parts are not original equipment parts and are not sponsored, affiliated, or otherwise connected with any major brand.

1) Non-Flange, Semi Finished also available as, 31358343. 2) 3 Bolt, Splined Nose, Rope Seal

4.248 Diesel

ENGINE INFORMATION

4.248 Diesel

4 CYL, LIP SEAL

BORE: 3.9785" 101.054mm



DESCRIPTION	PART NO.
MAJOR OH KIT	A-OK461
IN FRAME OH KIT	A-IK461

For Models: (TRACTOR: (194, 275, 285, 290, 590 ALL E-SN U123424L>))

ENGINE COMPONENT PARTS

NOTICE: Parts included in the overhaul kits are indicated as follows:

M parts included in MAJOR OVERHAUL KITS

I parts included in IN FRAME OVERHAUL KITS



DESCRIPTION	PART NO	SIZE	QTY	KIT
Piston Liner Kit	A-CK2481		4	MI
Piston	A-U5LP0009		4	
Liner, Cylinder (Finished) 4.248 Late	A-3135X034		4	
Rings, Piston	A-41158022		4	



DESCRIPTION	PART NO	SIZE	QTY	KIT
Bearing Set, Main (5)	A-81558	STD	1	M
Bearing Set, Main (5)	A-81558A	.010	1	M
Bearing Set, Main (5)	A-81558B	.020	1	M
Bearing Set, Main (5)	A-81558C	.030	1	M



DESCRIPTION	PART NO	SIZE	QTY	KIT
Bearing Set, Conn Rod	A-85042	STD	1	MI
Bearing Set, Conn Rod	A-85042A	.010	1	MI
Bearing Set, Conn Rod	A-85042B	.020	1	MI
Bearing Set, Conn Rod	A-85042C	.030	1	MI



DESCRIPTION	PART NO	SIZE	QTY	KIT
Washer Set, Thrust (4)	A-31137551/61	STD	1	M



DESCRIPTION	PART NO	SIZE	QTY	KIT
Seal, Front Crankshaft	A-2418F436		1	M
Seal, Rear Crankshaft	A-303158411		1	M
Crankshaft ¹	A-3637401M91		1	



DESCRIPTION	PART NO	SIZE	QTY	KIT
Valve Train Kit	A-VTK406		1	M
Valve, Intake	A-31431641		4	
Valve, Exhaust	A-31431881		4	
Guide, Intake Valve	A-3343F002		4	
Guide, Exhaust Valve	A-3343J002		4	
Spring, Valve Inner	A-31744131		8	
Spring, Valve Outer	A-31745121		8	
Keeper, Valve	A-33173108		8	
Seal, Valve	A-33817117		8	



DESCRIPTION	PART NO	SIZE	QTY	KIT
Bushing, Conn Rod	A-31134123		4	M
Bolt, Conn Rod	A-4222485M1		8	MI
Nut, Conn Rod	A-33221328		8	MI
Connecting Rod	A-ZZ90009		4	



DESCRIPTION	PART NO	SIZE	QTY	KIT
Gasket, Upper Set	A-U5LT0065		1	MI
Gasket, Lower Set w/o Seal	A-U5LB0045		1	MI
Gasket, Head	A-3681E036		1	
Gasket Set, Oil Pan	A-U5MK0600		1	



DESCRIPTION	PART NO	SIZE	QTY	KIT
Bearing, Camshaft	A-31134132		1	M
Camshaft ²	A-31415321		1	
Camshaft ³	A-736818M1		1	
Tappet	A-31434163		8	
Rod, Push	A-31434307		8	
Shaft, Rocker	A-ZZ90032		1	
Rocker Arm, LH	A-41151483		4	
Arm, RH Rocker	A-41151484		4	
Bushing, Rocker Shaft	A-2511425		8	



DESCRIPTION	PART NO	SIZE	QTY	KIT
Gear, Crankshaft	A-31171681		1	
Gear, Camshaft	A-31171353		1	
Gear, Idler ⁴	A-41115023		1	



DESCRIPTION	PART NO	SIZE	QTY	KIT
Pump, Fuel Lift Transfer	A-2641728		1	
Pump, Oil ⁵	A-3637489M91			



DESCRIPTION	PART NO	SIZE	QTY	KIT
Assembly Lube; 8oz	A-10152		1	
Assembly lube; Case of 12-8oz bottles	A-10153		1	

Parts are not original equipment parts and are not sponsored, affiliated, or otherwise connected with any major brand.

ALLIS CHALMERS
CASE-IH
CATERPILLAR
CLARK
DEUTZ
FIAT
FORD / NEW HOLLAND
GEHL
HYSTER
IMT
INGERSOLL RAND
JACOBSEN
JCB
JOHN DEERE
LANDINI
LEYLAND
LINCOLN ELECTRIC
MASSEY FERGUSON
MELROE
MICHIGAN
OWATTONA
PERKINS USA
RENAULT
SULAIR CORP
VERMEER
WHITE/OLIVER
ZETOR

1) Splined Nose- 3 Bolt, Lip Seal 2) eng SN <U106654N 3) eng SN U108197N>, check w/ build list 4) check w/ build list 5) used w/ balancer unit P4111K051

4.318 Diesel

ENGINE INFORMATION

4.318 Diesel

4 CYL, LIP SEAL

BORE: 4.5004" 104.313mm



DESCRIPTION	PART NO.
MAJOR OH KIT	A-OK490
IN FRAME OH KIT	A-IK490





For Models: (TRACTOR: 285, 595, 1080, 1085), (COMBINE: 540)





ENGINE COMPONENT PARTS





NOTICE: Parts included in the overhaul kits are indicated as follows:

M parts included in MAJOR OVERHAUL KITS



I parts included in IN FRAME OVERHAUL KITS



DESCRIPTION	PART NO	SIZE	QTY	KIT
 Piston Liner Kit	A-CK318		4	MI
 Piston	A-86716		4	
 Liner, Cylinder (Finished) 4.318 ¹	A-31358534		4	
 Rings, Piston	A-41158118		4	

DESCRIPTION	PART NO	SIZE	QTY	KIT
 Bearing Set, Main	A-68085	STD	1	M
 Bearing Set, Main	A-68085A	.010	1	M
 Bearing Set, Main	A-68085B	.020	1	M
 Bearing Set, Main	A-68085C	.030	1	M

DESCRIPTION	PART NO	SIZE	QTY	KIT
 Bearing Set, Conn Rod	A-85041	STD	1	MI
 Bearing Set, Conn Rod	A-85041A	.010	1	MI
 Bearing Set, Conn Rod	A-85041B	.020	1	MI
 Bearing Set, Conn Rod	A-85041C	.030	1	MI

DESCRIPTION	PART NO	SIZE	QTY	KIT
 Washer Set, Thrust (4)	A-31137551/61	STD	1	M

DESCRIPTION	PART NO	SIZE	QTY	KIT
 Seal, Front Crankshaft	A-2415346		1	M
 Seal, Rear Crankshaft	A-303158411		1	M

DESCRIPTION	PART NO	SIZE	QTY	KIT
 Stud, Cylinder Head	A-746215M1		17	
 Nut, Cylinder Head	A-1476232X1		17	

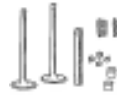

DESCRIPTION	PART NO	SIZE	QTY	KIT
Valve Train Kit	A-VTK408		1	M
Valve, Intake	A-31431154		4	
Valve, Exhaust	A-31431671		4	
Guide, Intake & Exhaust Valve	A-33432532		8	
Spring, Valve Inner	A-31744131		8	
Spring, Valve Outer	A-31745121		8	
Keeper, Valve	A-33173108		8	



DESCRIPTION	PART NO	SIZE	QTY	KIT
Bushing, Conn Rod	A-0050128		4	MI

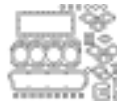

DESCRIPTION	PART NO	SIZE	QTY	KIT
Gasket, Upper Set	A-69048		1	MI
Gasket, Lower Set w/o Seal	A-68211		1	MI
Gasket, Head	A-36812348		1	



DESCRIPTION	PART NO	SIZE	QTY	KIT
Bushing, Rocker Shaft	A-2511425		8	



DESCRIPTION	PART NO	SIZE	QTY	KIT
Pump, Oil	A-41314113		1	
Pump, Fuel Lift w/o Sediment Bowl ²	A-3637286M91		1	



DESCRIPTION	PART NO	SIZE	QTY	KIT
Assembly Lube; 8oz	A-10152		1	
Assembly lube; Case of 12-8oz bottles	A-10153		1	

Parts are not original equipment parts and are not sponsored, affiliated, or otherwise connected with any major brand.

1) no flame ring 2) 2 Bolt Mount

6.354 Diesel

ENGINE INFORMATION

6.354 Diesel

6 CYL ^ BOTH ROPE & LIP SEAL INCLUDED IN KIT

BORE: 3.8770" 98.476mm, PIN: 1 3/8", 5 RING PISTON



DESCRIPTION	PART NO.
MAJOR OH KIT	A-OK511
IN FRAME OH KIT	A-IK511

For Models: (TRACTOR: 1100 E-SN <354UA10361)

ENGINE COMPONENT PARTS

NOTICE: Parts included in the overhaul kits are indicated as follows:

M parts included in MAJOR OVERHAUL KITS

I parts included in IN FRAME OVERHAUL KITS

DESCRIPTION	PART NO	SIZE	QTY	KIT
Piston Liner Kit	A-U5MK0127		6	MI
Piston	A-86740		6	
Liner, Cylinder	A-31358394		6	
Rings, Piston	A-41158041		6	



DESCRIPTION	PART NO	SIZE	QTY	KIT
Bearing Set, Main	A-85010	STD	1	M
Bearing Set, Main	A-85010A	.010	1	M
Bearing Set, Main	A-85010B	.020	1	M
Bearing Set, Main	A-85010C	.030	1	M



DESCRIPTION	PART NO	SIZE	QTY	KIT
Bearing Set, Conn Rod	A-85043	STD	1	MI
Bearing Set, Conn Rod	A-85043A	.010	1	MI
Bearing Set, Conn Rod	A-85043B	.020	1	MI
Bearing Set, Conn Rod	A-85043C	.030	1	MI



DESCRIPTION	PART NO	SIZE	QTY	KIT
Washer Set, Thrust (4)	A-31137551/61	STD	1	M
Washer Set, Thrust (4)	A-W2105L		1	M



DESCRIPTION	PART NO	SIZE	QTY	KIT
Seal, Front Crankshaft	A-2418F436		1	M
Seal, Rear Crankshaft ¹	A-303158411		1	M
Seal, Rear Crankshaft Rope ¹	A-36883108		1	
Crankshaft, Splined Nose, Rope Seal ^{2,3}	A-3638303M1		1	
Crankshaft, Splined Nose, Lip Seal ^{4,5}	A-3637424M91		1	



Parts are not original equipment parts and are not sponsored, affiliated, or otherwise connected with any major brand.



DESCRIPTION	PART NO	SIZE	QTY	KIT
Valve Train Kit	A-VTK610		1	M
Valve, Intake	A-31431315		6	
Valve, Exhaust	A-3142A052		6	
Guide, Intake Valve	A-3343F002		6	
Guide, Exhaust Valve	A-3343J002		6	
Spring, Valve Inner	A-31744131		12	
Spring, Valve Outer	A-31745121		12	
Seal, Valve	A-33817117		12	
Keeper, Valve	A-33173108		12	



DESCRIPTION	PART NO	SIZE	QTY	KIT
Bushing, Conn Rod	A-31134123		6	M
Bolt, Conn Rod	A-4222485M1		12	MI
Nut, Conn Rod	A-33221328		12	MI
Connecting Rod	A-ZZ90009		6	

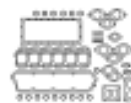

DESCRIPTION	PART NO	SIZE	QTY	KIT
Gasket, Upper Set	A-U5LT0021		1	MI
Gasket, Lower Set w/Rope	A-U5LB0056		1	MI
Gasket, Head	A-36812548		1	



DESCRIPTION	PART NO	SIZE	QTY	KIT
Tappet	A-31434163		12	
Rod, Push	A-31434307		12	
Shaft, Rocker	A-ZZ90046		1	
Rocker Arm, LH	A-41151483		6	
Arm, RH Rocker	A-41151484		6	
Bushing, Rocker Shaft	A-2511425		12	



DESCRIPTION	PART NO	SIZE	QTY	KIT
Shaft, Aux. Drive	A-31173422		1	
Shaft & Gear Assembly	A-41115367		1	
Bushing, Front	A-31134129		1	
Bushing, Rear	A-2511447		1	
Seal	A-2418F432		1	



DESCRIPTION	PART NO	SIZE	QTY	KIT
Pump, Oil ^{6,7}	A-41314067		1	
Pump, Oil ^{6,8}	A-739400M91		1	
Pump, Fuel Lift (2 Hole Mount)	A-3637309M1		1	



DESCRIPTION	PART NO	SIZE	QTY	KIT
Assembly Lube; 8oz	A-10152		1	
Assembly lube; Case of 12-8oz bottles	A-10153		1	

ALLIS CHALMERS
CASE-IH
CATERPILLAR
CLARK
DEUTZ
FIAT
FORD / NEW HOLLAND
GEHL
HYSTER
IMT
INGERSOLL RAND
JACOBSEN
JCB
JOHN DEERE
LANDINI
LEYLAND
LINCOLN ELECTRIC
MASSEY FERGUSON
MELROE
MICHIGAN
OWATTONA
PERKINS USA
RENAULT
SULAIR CORP
VERMEER
WHITE/ OLIVER
ZETOR

1) both rear seal types included in kit 2) Eng SN <U327088L 3) Eng SN <U12128L, Rope Seal 4) Eng SN U327089L> 5) Eng SN U12128L>, Lip Seal 6) Check w/ build list 7) Pump is 11.5" Long, w/ 8" Shaft Length 8) Pump is 8.5" Long w/ 4" Shaft Length

6.354 Diesel

ENGINE INFORMATION

6.354 Diesel

6 CYL, ROPE SEAL

BORE: 3.8770" 98.476mm, PIN: 1 3/8", 5 RING PISTON



DESCRIPTION	PART NO.
MAJOR OH KIT	A-OK652
IN FRAME OH KIT	A-IK652

For Models: (TRACTOR: 1100 E-SN 354UA10362>)

ENGINE COMPONENT PARTS

NOTICE: Parts included in the overhaul kits are indicated as follows:

M parts included in MAJOR OVERHAUL KITS

I parts included in IN FRAME OVERHAUL KITS

DESCRIPTION	PART NO	SIZE	QTY	KIT
Piston Liner Kit	A-U5MK0127		6	MI
Piston	A-86740		6	
Liner, Cylinder	A-31358394		6	
Rings, Piston	A-41158041		6	

DESCRIPTION	PART NO	SIZE	QTY	KIT
Bearing Set, Main	A-85010	STD	1	M
Bearing Set, Main	A-85010A	.010	1	M
Bearing Set, Main	A-85010B	.020	1	M
Bearing Set, Main	A-85010C	.030	1	M

DESCRIPTION	PART NO	SIZE	QTY	KIT
Bearing Set, Conn Rod	A-85043	STD	1	MI
Bearing Set, Conn Rod	A-85043A	.010	1	MI
Bearing Set, Conn Rod	A-85043B	.020	1	MI
Bearing Set, Conn Rod	A-85043C	.030	1	MI

DESCRIPTION	PART NO	SIZE	QTY	KIT
Washer Set, Thrust (4)	A-31137551/61	STD	1	M

DESCRIPTION	PART NO	SIZE	QTY	KIT
Seal, Front Crankshaft	A-2418F436		1	M

DESCRIPTION	PART NO	SIZE	QTY	KIT
Crankshaft, Splined Nose, Rope Seal	A-3638303M1		1	

DESCRIPTION	PART NO	SIZE	QTY	KIT
Valve Train Kit	A-VTK610		1	M
Valve, Intake	A-31431641		6	
Valve, Exhaust	A-31431881		6	

DESCRIPTION	PART NO	SIZE	QTY	KIT
Guide, Intake Valve	A-3343F002		6	
Guide, Exhaust Valve	A-3343J002		6	
Spring, Valve Inner	A-31744131		12	
Spring, Valve Outer	A-31745121		12	
Seal, Valve	A-33817117		12	
Keeper, Valve	A-33173108		12	



DESCRIPTION	PART NO	SIZE	QTY	KIT
Bushing, Conn Rod	A-31134123		6	M
Bolt, Conn Rod	A-4222485M1		12	MI
Nut, Conn Rod	A-33221328		12	MI
Connecting Rod	A-ZZ90009		6	

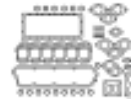

DESCRIPTION	PART NO	SIZE	QTY	KIT
Gasket, Upper Set	A-U5LT0026		1	MI
Gasket, Lower Set w/Rope	A-U5LB0056		1	MI
Gasket, Head	A-36812547		1	



DESCRIPTION	PART NO	SIZE	QTY	KIT
Tappet	A-31434163		12	
Rod, Push	A-31434307		12	
Shaft, Rocker	A-ZZ90046		1	
Rocker Arm, LH	A-41151483		6	
Arm, RH Rocker	A-41151484		6	
Bushing, Rocker Shaft	A-2511425		12	



DESCRIPTION	PART NO	SIZE	QTY	KIT
Shaft, Aux. Drive	A-31173422		1	
Shaft & Gear Assembly	A-41115367		1	
Bushing, Front	A-31134129		1	
Bushing, Rear	A-2511447		1	
Seal	A-2418F432		1	



DESCRIPTION	PART NO	SIZE	QTY	KIT
Pump, Oil 1,2	A-41314067		1	
Pump, Fuel Lift (2 Hole Mount)	A-3637309M1		1	



DESCRIPTION	PART NO	SIZE	QTY	KIT
Assembly Lube; 8oz	A-10152		1	
Assembly lube; Case of 12-8oz bottles	A-10153		1	

Parts are not original equipment parts and are not sponsored, affiliated, or otherwise connected with any major brand.

1) Check w/ build list 2) Pump is 11.5" Long, w/ 8" Shaft Length

Parts are not original equipment parts and are not sponsored, affiliated, or otherwise connected with any major brand.

T6.354 Diesel

ENGINE INFORMATION

T6.354 Diesel

6 CYL, ROPE SEAL

BORE: 3.8770" 98.476mm, PIN: 1 1/2", 4 RING PISTON

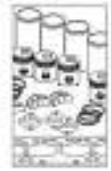

DESCRIPTION	PART NO.
MAJOR OH KIT	A-OK660
IN FRAME OH KIT	A-IK660

For Models: (TRACTOR: 1130 E-SN <354UA3355T)

ENGINE COMPONENT PARTS

NOTICE: Parts included in the overhaul kits are indicated as follows:

M parts included in MAJOR OVERHAUL KITS

I parts included in IN FRAME OVERHAUL KITS

DESCRIPTION	PART NO.	SIZE	QTY	KIT
Piston Liner Kit	A-CK354		6	M
Piston	A-86726		6	
Liner, Cylinder	A-31358394		6	
Rings, Piston	A-41158031		6	

DESCRIPTION	PART NO.	SIZE	QTY	KIT
Bearing Set, Main	A-U5MB0011	STD	1	M
Bearing Set, Main	A-U5MB0011A	.010	1	M
Bearing Set, Main	A-U5MB0011B	.020	1	M
Bearing Set, Main	A-U5MB0011C	.030	1	M

DESCRIPTION	PART NO.	SIZE	QTY	KIT
Bearing Set, Conn Rod	A-U5ME0007	STD	1	M
Bearing Set, Conn Rod	A-U5ME0007A	.010	1	M
Bearing Set, Conn Rod	A-U5ME0007B	.020	1	M

DESCRIPTION	PART NO.	SIZE	QTY	KIT
Washer Set, Thrust (4)	A-31137551/61	STD	1	M

DESCRIPTION	PART NO.	SIZE	QTY	KIT
Seal, Front Crankshaft	A-2418F436		1	M
Seal, Rear Crankshaft Rope	A-36883108		1	
Crankshaft	A-ZZ90159		1	

DESCRIPTION	PART NO.	SIZE	QTY	KIT
Valve Train Kit	A-VTK610		1	M
Valve, Intake	A-31431315		6	
Valve, Exhaust	A-3142A052		6	
Guide, Intake Valve	A-3343F002		6	
Guide, Exhaust Valve	A-3343J002		6	
Spring, Valve Inner	A-31744131		12	
Spring, Valve Outer	A-31745121		12	
Seal, Valve	A-33817117		12	
Keeper, Valve	A-33173108		12	

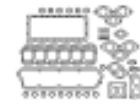

DESCRIPTION	PART NO.	SIZE	QTY	KIT
Bushing, Conn Rod	A-31134134		6	M
Bolt, Conn Rod	A-4222485M1		12	M
Nut, Conn Rod	A-33221328		12	M

DESCRIPTION	PART NO.	SIZE	QTY	KIT
Gasket, Upper Set	A-U5LT0021		1	M
Gasket, Lower Set w/Rope	A-U5LB0056		1	M
Gasket, Head	A-36812548		1	

DESCRIPTION	PART NO.	SIZE	QTY	KIT
Tappet	A-31434163		12	
Rod, Push	A-31434307		12	
Shaft, Rocker	A-ZZ90046		1	
Rocker Arm, LH	A-41151483		6	
Arm, RH Rocker	A-41151484		6	
Bushing, Rocker Shaft	A-2511425		12	

DESCRIPTION	PART NO.	SIZE	QTY	KIT
Shaft, Aux. Drive	A-31173421		1	
Shaft & Gear Assembly	A-41115367		1	
Bushing, Front	A-31134129		1	
Bushing, Rear	A-2511447		1	
Seal	A-2418F432		1	

DESCRIPTION	PART NO.	SIZE	QTY	KIT
Pump, Oil ^{1,2}	A-41314067		1	
Pump, Fuel Lift (2 Hole Mount)	A-3637309M1		1	

DESCRIPTION	PART NO.	SIZE	QTY	KIT
Assembly Lube; 8oz	A-10152		1	
Assembly lube; Case of 12-8oz bottles	A-10153		1	

ALLIS CHALMERS

CASE-IH

CATERPILLAR

CLARK

DEUTZ

FIAT

FORD / NEW HOLLAND

GEHL

HYSTER

IMT

INGERSOLL RAND

JACOBSEN

JCB

JOHN DEERE

LANDINI

LEYLAND

LINCOLN ELECTRIC

MASSEY FERGUSON

MELROE

MICHIGAN

OWATTONA

PERKINS USA

RENAULT

SULAIR CORP

VERMEER

WHITE/OLIVER

ZETOR

1) Check w/ build list 2) Pump is 11.5" Long, w/ 8" Shaft Length

T6.354.1 / TC6.354.1 Diesel

ENGINE INFORMATION

T6.354.1 / TC6.354.1 Diesel

TURBOCHARGED ^ 6 CYL, LIP SEAL

BORE: 3.8770" 98.476mm, PIN: 1 1/2", 4 RING PISTON



DESCRIPTION	PART NO.
MAJOR OH KIT	A-0K661
IN FRAME OH KIT	A-1K661

For Models: (TRACTOR: 1105, 1135), (COMBINE: 760 E-SN UA48970L>), (TRACTOR: 1130 E-SN 354UA3355T>), (COMBINE: 750)

ENGINE COMPONENT PARTS

NOTICE: Parts included in the overhaul kits are indicated as follows:

M parts included in MAJOR OVERHAUL KITS

I parts included in IN FRAME OVERHAUL KITS

DESCRIPTION	PART NO	SIZE	QTY	KIT
Piston Liner Kit	A-CK354		6	MI
Piston	A-86726		6	
Liner, Cylinder	A-31358394		6	
Rings, Piston	A-41158031		6	

DESCRIPTION	PART NO	SIZE	QTY	KIT
Bearing Set, Main	A-U5MB0011	STD	1	M
Bearing Set, Main	A-U5MB0011A	.010	1	M
Bearing Set, Main	A-U5MB0011B	.020	1	M
Bearing Set, Main	A-U5MB0011C	.030	1	M

DESCRIPTION	PART NO	SIZE	QTY	KIT
Bearing Set, Conn Rod	A-U5ME0007	STD	1	MI
Bearing Set, Conn Rod	A-U5ME0007A	.010	1	MI
Bearing Set, Conn Rod	A-U5ME0007B	.020	1	MI

DESCRIPTION	PART NO	SIZE	QTY	KIT
Bushing, Conn Rod	A-31134134		6	M
Bolt, Conn Rod	A-4222485M1		12	MI
Nut, Conn Rod	A-33221328		12	MI

DESCRIPTION	PART NO	SIZE	QTY	KIT
Washer Set, Thrust (4)	A-31137551/61	STD	1	M

DESCRIPTION	PART NO	SIZE	QTY	KIT
Seal, Front Crankshaft	A-2418F436		1	M
Seal, Rear Crankshaft	A-303158411		1	M
Crankshaft	A-ZZ90091		1	

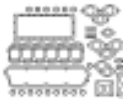
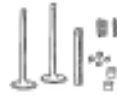

DESCRIPTION	PART NO	SIZE	QTY	KIT
Valve Train Kit	A-VTK610		1	M
Valve, Intake	A-31431315		6	
Valve, Exhaust	A-3142A052		6	
Guide, Intake Valve	A-3343F002		6	
Guide, Exhaust Valve	A-3343J002		6	
Spring, Valve Inner	A-31744131		12	
Spring, Valve Outer	A-31745121		12	
Seal, Valve	A-33817117		12	
Keeper, Valve	A-33173108		12	

DESCRIPTION	PART NO	SIZE	QTY	KIT
Gasket, Upper Set	A-U5LT0026		1	MI
Gasket, Lower Set w/Rope	A-U5LB0056		1	MI
Gasket, Head	A-36812547		1	

DESCRIPTION	PART NO	SIZE	QTY	KIT
Tappet	A-31434163		12	
Rod, Push	A-31434307		12	
Shaft, Rocker	A-ZZ90046		1	
Rocker Arm, LH	A-41151483		6	
Arm, RH Rocker	A-41151484		6	
Bushing, Rocker Shaft	A-2511425		12	

DESCRIPTION	PART NO	SIZE	QTY	KIT
Shaft, Aux. Drive ¹	A-31173421		1	
Shaft & Gear Assembly	A-41115367		1	
Bushing, Front	A-31134129		1	
Bushing, Rear	A-2511447		1	
Seal	A-2418F432		1	

DESCRIPTION	PART NO	SIZE	QTY	KIT
Pump, Oil ^{2,3}	A-41314067		1	
Pump, Fuel Lift (2 Hole Mount)	A-3637309M1		1	

DESCRIPTION	PART NO	SIZE	QTY	KIT
Assembly Lube; 8oz	A-10152		1	
Assembly lube; Case of 12-8oz bottles	A-10153		1	

Parts are not original equipment parts and are not sponsored, affiliated, or otherwise connected with any major brand.

1) use 31173422 on build TH22481 2) Check w/ build list 3) Pump is 11.5" Long, w/ 8" Shaft Length

Parts are not original equipment parts and are not sponsored, affiliated, or otherwise connected with any major brand.

ENGINE INFORMATION

6.354.4 Diesel

6 CYL, LIP SEAL

BORE: 3.8770" 98.476mm, PIN: 1 3/8", 5 RING PISTON



DESCRIPTION	PART NO.
MAJOR OH KIT	A-OK671
IN FRAME OH KIT	A-1K671

For Models: (TRACTOR: 1014), (COMBINE: 550, TX550)

ENGINE COMPONENT PARTS

NOTICE: Parts included in the overhaul kits are indicated as follows:

M parts included in MAJOR OVERHAUL KITS

I parts included in IN FRAME OVERHAUL KITS

DESCRIPTION	PART NO	SIZE	QTY	KIT
Piston Liner Kit	A-U5MK0127		6	MI
Piston	A-86740		6	
Liner, Cylinder	A-31358394		6	
Rings, Piston	A-41158041		6	



DESCRIPTION	PART NO	SIZE	QTY	KIT
Bearing Set, Main (7)	A-U5MB0007	STD	1	M
Bearing Set, Main (7)	A-U5MB0007A	.010	1	M
Bearing Set, Main (7)	A-U5MB0007B	.020	1	M
Bearing Set, Main (7)	A-68079C	.030	1	M



DESCRIPTION	PART NO	SIZE	QTY	KIT
Bearing Set, Conn Rod	A-85043	STD	1	MI
Bearing Set, Conn Rod	A-85043A	.010	1	MI
Bearing Set, Conn Rod	A-85043B	.020	1	MI
Bearing Set, Conn Rod	A-85043C	.030	1	MI



DESCRIPTION	PART NO	SIZE	QTY	KIT
Bushing, Conn Rod	A-31134123		6	M
Bolt, Conn Rod	A-4222485M1		12	MI
Nut, Conn Rod	A-33221328		12	MI
Connecting Rod	A-ZZ90009		6	



DESCRIPTION	PART NO	SIZE	QTY	KIT
Washer Set, Thrust (4)	A-31137551/61	STD	1	M



DESCRIPTION	PART NO	SIZE	QTY	KIT
Seal, Front Crankshaft	A-2418F436		1	M
Seal, Rear Crankshaft	A-303158411		1	M
Crankshaft, Keyed Nose, Lip Seal	A-3637408M91		1	



6.354.4 Diesel

DESCRIPTION	PART NO	SIZE	QTY	KIT
Valve Train Kit	A-VTK611		1	M
Valve, Intake	A-31431315		6	
Valve, Exhaust	A-3142A051		6	



DESCRIPTION	PART NO	SIZE	QTY	KIT
Guide, Intake Valve	A-3343F002		6	
Guide, Exhaust Valve	A-3343J002		6	
Spring, Valve Inner	A-31744131		12	
Spring, Valve Outer	A-31745121		12	
Seal, Valve	A-33817117		12	
Keeper, Valve	A-33173108		12	

DESCRIPTION	PART NO	SIZE	QTY	KIT
Gasket, Upper Set	A-U5LT0017		1	MI
Gasket, Lower Set w/Rope	A-U5LB0056		1	MI
Gasket, Head	A-3681H202		1	

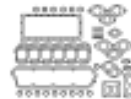

DESCRIPTION	PART NO	SIZE	QTY	KIT
Tappet	A-31434163		12	
Rod, Push	A-31434307		12	
Shaft, Rocker	A-ZZ90046		1	
Rocker Arm, LH	A-41151483		6	
Arm, RH Rocker	A-41151484		6	
Bushing, Rocker Shaft	A-2511425		12	



DESCRIPTION	PART NO	SIZE	QTY	KIT
Shaft, Aux. Drive ¹	A-31173423		1	
Shaft & Gear Assembly	A-41115367		1	
Bushing, Front	A-31134129		1	
Bushing, Rear	A-2511447		1	
Seal	A-2418F432		1	



DESCRIPTION	PART NO	SIZE	QTY	KIT
Pump, Oil	A-4132F015		1	
Pump, Fuel Lift Transfer	A-2641729		1	



DESCRIPTION	PART NO	SIZE	QTY	KIT
Assembly Lube; 8oz	A-10152		1	
Assembly lube; Case of 12-8oz bottles	A-10153		1	



ALLIS CHALMERS
CASE-IH
CATERPILLAR
CLARK
DEUTZ
FIAT
FORD / NEW HOLLAND
GEHL
HYSTER
IMT
INGERSOLL RAND
JACOBSEN
JCB
JOHN DEERE
LANDINI
LEYLAND
LINCOLN ELECTRIC
MASSEY FERGUSON
MELROE
MICHIGAN
OWATTONA
PERKINS USA
RENAULT
SULAIR CORP
VERMEER
WHITE/ OLIVER
ZETOR

1) do not use on build TW70008

6.354.4 Diesel

ENGINE INFORMATION

6.354.4 Diesel

6 CYL, LIP SEAL

BORE: 3.8770" 98.476mm, PIN: 1 3/8", 3 RING PISTON



DESCRIPTION	PART NO.
MAJOR OH KIT	A-OK673
IN FRAME OH KIT	A-IK673

For Models: (TRACTOR: 2675, (3090, 699 ALL E-SN <U737602M))

ENGINE COMPONENT PARTS

NOTICE: Parts included in the overhaul kits are indicated as follows:

M parts included in MAJOR OVERHAUL KITS

I parts included in IN FRAME OVERHAUL KITS

DESCRIPTION	PART NO	SIZE	QTY	KIT
Piston Liner Kit	A-CK619		6	MI
Piston	A-U5LP0019		6	
Liner, Cylinder	A-31358394		6	
Rings, Piston	A-41158017		6	

DESCRIPTION	PART NO	SIZE	QTY	KIT
Bearing Set, Main (7)	A-U5MB0007	STD	1	M
Bearing Set, Main (7)	A-U5MB0007A	.010	1	M
Bearing Set, Main (7)	A-U5MB0007B	.020	1	M
Bearing Set, Main (7)	A-68079C	.030	1	M

DESCRIPTION	PART NO	SIZE	QTY	KIT
Bearing Set, Conn Rod	A-85043	STD	1	MI
Bearing Set, Conn Rod	A-85043A	.010	1	MI
Bearing Set, Conn Rod	A-85043B	.020	1	MI
Bearing Set, Conn Rod	A-85043C	.030	1	MI

DESCRIPTION	PART NO	SIZE	QTY	KIT
Bushing, Conn Rod	A-31134123		6	M
Bolt, Conn Rod	A-4222485M1		12	MI
Nut, Conn Rod	A-33221328		12	MI
Connecting Rod	A-ZZ90009		6	

DESCRIPTION	PART NO	SIZE	QTY	KIT
Washer Set, Thrust (4)	A-31137551/61	STD	1	M

DESCRIPTION	PART NO	SIZE	QTY	KIT
Seal, Front Crankshaft	A-2418F436		1	M
Seal, Rear Crankshaft	A-303158411		1	M
Crankshaft, Keyed Nose, Lip Seal	A-3637408M91		1	



DESCRIPTION	PART NO	SIZE	QTY	KIT
Valve Train Kit	A-VTK611		1	M
Valve, Intake	A-31431315		6	
Valve, Exhaust	A-3142A051		6	
Guide, Intake Valve	A-3343F002		6	
Guide, Exhaust Valve	A-3343J002		6	
Spring, Valve Inner	A-31744131		12	
Spring, Valve Outer	A-31745121		12	
Seal, Valve	A-33817117		12	
Keeper, Valve	A-33173108		12	

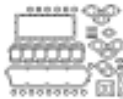

DESCRIPTION	PART NO	SIZE	QTY	KIT
Gasket, Upper Set	A-U5LT0033		1	MI
Gasket, Lower Set w/Rope	A-U5LB0056		1	MI
Gasket, Head	A-3681H202		1	



DESCRIPTION	PART NO	SIZE	QTY	KIT
Tappet	A-31434163		12	
Rod, Push	A-31434307		12	
Shaft, Rocker	A-ZZ90046		1	
Rocker Arm, LH	A-41151483		6	
Arm, RH Rocker	A-41151484		6	
Bushing, Rocker Shaft	A-2511425		12	



DESCRIPTION	PART NO	SIZE	QTY	KIT
Shaft, Aux. Drive ¹	A-31173423		1	
Shaft & Gear Assembly	A-41115367		1	
Bushing, Front	A-31134129		1	
Bushing, Rear	A-2511447		1	
Seal	A-2418F432		1	
Gear, Camshaft ²	A-736254M1		1	



DESCRIPTION	PART NO	SIZE	QTY	KIT
Pump, Oil	A-4132F015		1	
Pump, Fuel Lift Transfer	A-2641729		1	



DESCRIPTION	PART NO	SIZE	QTY	KIT
Assembly Lube; 8oz	A-10152		1	
Assembly lube; Case of 12-8oz bottles	A-10153		1	

Parts are not original equipment parts and are not sponsored, affiliated, or otherwise connected with any major brand.

1) do not use on build TW70008 2) use only w/ build no TW31008

Parts are not original equipment parts and are not sponsored, affiliated, or otherwise connected with any major brand.

ENGINE INFORMATION

6.354.4 Diesel

6 CYL, LIP SEAL

BORE: 3.8770" 98.476mm, PIN: 1 3/8", 3 RING PISTON



DESCRIPTION	PART NO.
MAJOR OH KIT	A-OK674
IN FRAME OH KIT	A-IK674

For Models: (TRACTOR: (3090, 699 ALL E-SN U737603>))

ENGINE COMPONENT PARTS

NOTICE: Parts included in the overhaul kits are indicated as follows:

M parts included in MAJOR OVERHAUL KITS

I parts included in IN FRAME OVERHAUL KITS

DESCRIPTION	PART NO	SIZE	QTY	KIT
Piston Liner Kit	A-CK619		6	MI
Piston	A-U5LP0021		6	
Liner, Cylinder	A-31358394		6	
Rings, Piston	A-41158017		6	

DESCRIPTION	PART NO	SIZE	QTY	KIT
Bearing Set, Main (7)	A-U5MB0007	STD	1	M
Bearing Set, Main (7)	A-U5MB0007A	.010	1	M
Bearing Set, Main (7)	A-U5MB0007B	.020	1	M
Bearing Set, Main (7)	A-68079C	.030	1	M

DESCRIPTION	PART NO	SIZE	QTY	KIT
Bearing Set, Conn Rod	A-85043	STD	1	MI
Bearing Set, Conn Rod	A-85043A	.010	1	MI
Bearing Set, Conn Rod	A-85043B	.020	1	MI
Bearing Set, Conn Rod	A-85043C	.030	1	MI

DESCRIPTION	PART NO	SIZE	QTY	KIT
Washer Set, Thrust (4)	A-31137551/61	STD	1	M

DESCRIPTION	PART NO	SIZE	QTY	KIT
Seal, Front Crankshaft	A-2418F436		1	M
Seal, Rear Crankshaft	A-303158411		1	M
Crankshaft, Keyed Nose, Lip Seal	A-3637408M91		1	

DESCRIPTION	PART NO	SIZE	QTY	KIT
Valve Train Kit	A-VTK611		1	M
Valve, Intake	A-31431315		6	
Valve, Exhaust	A-3142A051		6	
Guide, Intake Valve	A-3343F002		6	
Guide, Exhaust Valve	A-3343J002		6	
Spring, Valve Inner	A-31744131		12	
Spring, Valve Outer	A-31745121		12	
Seal, Valve	A-33817117		12	
Keeper, Valve	A-33173108		12	

6.354.4 Diesel

DESCRIPTION	PART NO	SIZE	QTY	KIT
Bushing, Conn Rod	A-31134123		6	M
Bolt, Conn Rod	A-4222485M1		12	MI
Nut, Conn Rod	A-33221328		12	MI
Connecting Rod	A-ZZ90009		6	

DESCRIPTION	PART NO	SIZE	QTY	KIT
Gasket, Upper Set	A-U5LT0033		1	MI
Gasket, Lower Set w/Rope	A-U5LB0056		1	MI
Gasket, Head	A-3681H202		1	

DESCRIPTION	PART NO	SIZE	QTY	KIT
Tappet	A-31434163		12	
Rod, Push	A-31434307		12	
Shaft, Rocker	A-ZZ90046		1	
Rocker Arm, LH	A-41151483		6	
Arm, RH Rocker	A-41151484		6	
Bushing, Rocker Shaft	A-2511425		12	

DESCRIPTION	PART NO	SIZE	QTY	KIT
Shaft, Aux. Drive ¹	A-31173423		1	
Shaft & Gear Assembly	A-41115367		1	
Bushing, Front	A-31134129		1	
Bushing, Rear	A-2511447		1	
Seal	A-2418F432		1	

DESCRIPTION	PART NO	SIZE	QTY	KIT
Pump, Oil	A-4132F015		1	
Pump, Fuel Lift Transfer	A-2641729		1	

DESCRIPTION	PART NO	SIZE	QTY	KIT
Assembly Lube; 8oz	A-10152		1	
Assembly lube; Case of 12-8oz bottles	A-10153		1	

ALLIS CHALMERS

CASE-IH

CATERPILLAR

CLARK

DEUTZ

FIAT

FORD / NEW HOLLAND

GEHL

HYSTER

IMT

INGERSOLL RAND

JACOBSEN

JCB

JOHN DEERE

LANDINI

LEYLAND

LINCOLN ELECTRIC

MASSEY FERGUSON

MELROE

MICHIGAN

OWATTONA

PERKINS USA

RENAULT

SULAIR CORP

VERMEER

WHITE/OLIVER

ZETOR

1) do not use on build TW70008

T6.354.4

ENGINE INFORMATION

T6.354.4

TURBOCHARGED ^ 6 CYL, LIP SEAL

BORE: 3.8770" 98.476mm, PIN: 1 1/2", 3 RING PISTON



DESCRIPTION	PART NO.
MAJOR OH KIT	A-OK680
IN FRAME OH KIT	A-IK680

For Models: (TRACTOR: 3650), (COMBINE: 560 UK, 660 UK, 750, 850)

ENGINE COMPONENT PARTS

NOTICE: Parts included in the overhaul kits are indicated as follows:

M parts included in MAJOR OVERHAUL KITS

I parts included in IN FRAME OVERHAUL KITS

DESCRIPTION	PART NO	SIZE	QTY	KIT
Piston Liner Kit	A-U5MK0071		6	MI
Piston	A-68803		6	
Liner, Cylinder	A-31358394		6	
Rings, Piston	A-41158005		6	

DESCRIPTION	PART NO	SIZE	QTY	KIT
Bearing Set, Main (7)	A-U5MB0007	STD	1	M
Bearing Set, Main (7)	A-U5MB0007A	.010	1	M
Bearing Set, Main (7)	A-U5MB0007B	.020	1	M
Bearing Set, Main (7)	A-68079C	.030	1	M

DESCRIPTION	PART NO	SIZE	QTY	KIT
Bearing Set, Conn Rod	A-U5ME0003	STD	1	MI
Bearing Set, Conn Rod	A-U5ME0003A	.010	1	MI
Bearing Set, Conn Rod	A-U5ME0003B	.020	1	MI
Bearing Set, Conn Rod	A-U5ME0003C	.030	1	MI

DESCRIPTION	PART NO	SIZE	QTY	KIT
Bushing, Conn Rod	A-31134131		6	M
Bolt, Conn Rod	A-4222485M1		12	MI
Nut, Conn Rod	A-33221328		12	MI
Connecting Rod (Turbo) ¹	A-ZZ90013		6	

DESCRIPTION	PART NO	SIZE	QTY	KIT
Washer Set, Thrust (4)	A-31137551/61	STD	1	M

DESCRIPTION	PART NO	SIZE	QTY	KIT
Seal, Front Crankshaft	A-2418F436		1	M
Seal, Rear Crankshaft	A-303158411		1	M
Crankshaft Kit	A-ZZ90105		1	

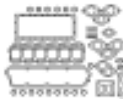

DESCRIPTION	PART NO	SIZE	QTY	KIT
Valve Train Kit	A-VTK611		1	M
Valve, Intake	A-31431315		6	
Valve, Exhaust	A-3142A051		6	

DESCRIPTION	PART NO	SIZE	QTY	KIT
Guide, Intake Valve	A-3343F002		6	
Guide, Exhaust Valve	A-3343J002		6	
Spring, Valve Inner	A-31744131		12	
Spring, Valve Outer	A-31745121		12	
Seal, Valve	A-33817117		12	
Keeper, Valve	A-33173108		12	

DESCRIPTION	PART NO	SIZE	QTY	KIT
Gasket, Upper Set	A-U5LT0018		1	MI
Gasket, Lower Set w/Rope	A-U5LB0056		1	MI
Gasket, Head	A-3681H202		1	

DESCRIPTION	PART NO	SIZE	QTY	KIT
Tappet	A-31434163		12	
Rod, Push	A-31434307		12	
Shaft, Rocker	A-ZZ90046		1	
Rocker Arm, LH	A-41151483		6	
Arm, RH Rocker	A-41151484		6	
Bushing, Rocker Shaft	A-2511425		12	

DESCRIPTION	PART NO	SIZE	QTY	KIT
Shaft, Aux. Drive	A-31173423		1	
Shaft & Gear Assembly	A-41115367		1	
Bushing, Front	A-31134129		1	
Bushing, Rear	A-2511447		1	

DESCRIPTION	PART NO	SIZE	QTY	KIT
Pump, Oil	A-4132F015		1	
Pump, Fuel Lift Transfer	A-2641729		1	

DESCRIPTION	PART NO	SIZE	QTY	KIT
Assembly Lube; 8oz	A-10152		1	
Assembly lube; Case of 12-8oz bottles	A-10153		1	

Parts are not original equipment parts and are not sponsored, affiliated, or otherwise connected with any major brand.

¹) check w/ build list

Parts are not original equipment parts and are not sponsored, affiliated, or otherwise connected with any major brand.

ENGINE INFORMATION

1006.60 Diesel

6 CYL, LIP SEAL

BORE: 3.9370" 100.00mm



DESCRIPTION	PART NO.
MAJOR OH KIT	A-OK690
IN FRAME OH KIT	A-IK690

For Models: (TRACTOR: 396, 399)

ENGINE COMPONENT PARTS

NOTICE: Parts included in the overhaul kits are indicated as follows:

M parts included in MAJOR OVERHAUL KITS

I parts included in IN FRAME OVERHAUL KITS

DESCRIPTION	PART NO	SIZE	QTY	KIT
 Piston Liner Kit	A-U5MK0142		6	MI
Piston	A-U5LL0015		6	
Liner, Cylinder	A-3135X042		6	
Rings, Piston	A-4181A019		6	

DESCRIPTION	PART NO	SIZE	QTY	KIT
 Bearing Set, Main (7)	A-U5MB0007	STD	1	M
Bearing Set, Main (7)	A-U5MB0007A	.010	1	M
Bearing Set, Main (7)	A-U5MB0007B	.020	1	M
Bearing Set, Main (7)	A-U5MB0007C	.030	1	M

DESCRIPTION	PART NO	SIZE	QTY	KIT
 Bearing Set, Conn Rod	A-85043	STD	1	MI
Bearing Set, Conn Rod	A-85043A	.010	1	MI
Bearing Set, Conn Rod	A-85043B	.020	1	MI
Bearing Set, Conn Rod	A-85043C	.030	1	MI

DESCRIPTION	PART NO	SIZE	QTY	KIT
 Washer Set, Thrust (4)	A-31137551/61	STD	1	M

DESCRIPTION	PART NO	SIZE	QTY	KIT
 Seal, Front Crankshaft	A-2418F436		1	M
Seal, Rear Crankshaft	A-303158411		1	M

DESCRIPTION	PART NO	SIZE	QTY	KIT
 Valve Train Kit	A-VTK612		1	M
Valve, Intake	A-3142L051		6	
Valve, Exhaust	A-3142A051		6	
Guide, Intake Valve	A-3343F002		6	
Guide, Exhaust Valve	A-3343J002		6	
Spring, Valve Inner	A-31744133		12	
Spring, Valve Outer	A-31745122		12	
Seal, Valve	A-33817117		12	
Keeper, Valve	A-33173108		12	

1006.60 Diesel

DESCRIPTION	PART NO	SIZE	QTY	KIT
 Bushing, Conn Rod	A-31134123		6	M
Bolt, Conn Rod	A-4222485M1		12	MI
Nut, Conn Rod	A-33221328		12	MI
Connecting Rod	A-ZZ90009		6	

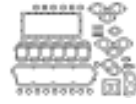
DESCRIPTION	PART NO	SIZE	QTY	KIT
 Gasket, Upper Set	A-U5LT0179		1	MI
Gasket, Lower Set w/o Seal	A-U5LB0153		1	MI
Gasket, Head	A-3681H205		1	

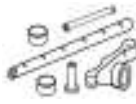
DESCRIPTION	PART NO	SIZE	QTY	KIT
 Camshaft	A-31416307		1	
Tappet	A-31434163		12	
Rod, Push	A-31434307		12	
Rocker Arm, LH	A-41151483		6	
Arm, RH Rocker	A-41151484		6	
Bushing, Rocker Shaft	A-2511425		12	

DESCRIPTION	PART NO	SIZE	QTY	KIT
 Pump, Fuel Lift Transfer	A-2641729		1	

DESCRIPTION	PART NO	SIZE	QTY	KIT
 Gear, Crankshaft	A-159162A		1	

DESCRIPTION	PART NO	SIZE	QTY	KIT
 Assembly Lube; 8oz	A-10152		1	
Assembly lube; Case of 12-8oz bottles	A-10153		1	

ALLIS CHALMERS

CASE-IH

CATERPILLAR

CLARK

DEUTZ

FIAT

FORD / NEW HOLLAND

GEHL

HYSTER

IMT

INGERSOLL RAND

JACOBSEN

JCB

JOHN DEERE

LANDINI

LEYLAND

LINCOLN ELECTRIC

MASSEY FERGUSON

MELROE

MICHIGAN

OWATTONA

PERKINS USA

RENAULT

SULAIR CORP

VERMEER

WHITE/ OLIVER

ZETOR

1006.60T Diesel

ENGINE INFORMATION

1006.60T Diesel

TURBOCHARGED ^ 6 CYL, LIP SEAL

BORE: 3.9370" 100.00mm



DESCRIPTION	PART NO.
MAJOR OH KIT	A-0K514
IN FRAME OH KIT	A-1K514

For Models: (TRACTOR: 3625 E-SN <557976X, 3660 W/ Engine Build# YB31236 Or YB31247)

ENGINE COMPONENT PARTS

NOTICE: Parts included in the overhaul kits are indicated as follows:

M parts included in MAJOR OVERHAUL KITS

I parts included in IN FRAME OVERHAUL KITS

DESCRIPTION	PART NO	SIZE	QTY	KIT
Piston Liner Kit	A-U5MK0275		6	MI
Piston	A-U5LL0014		6	
Liner, Cylinder	A-3135X042		6	
Rings, Piston	A-4181A021		6	

DESCRIPTION	PART NO	SIZE	QTY	KIT
Bearing Set, Main (7)	A-U5MB0007	STD	1	M
Bearing Set, Main (7)	A-U5MB0007A	.010	1	M
Bearing Set, Main (7)	A-U5MB0007B	.020	1	M
Bearing Set, Main (7)	A-U5MB0007C	.030	1	M
DESCRIPTION	PART NO	SIZE	QTY	KIT
Bearing Set, Conn Rod	A-U5ME0003	STD	1	MI
Bearing Set, Conn Rod	A-U5ME0003A	.010	1	MI
Bearing Set, Conn Rod	A-U5ME0003B	.020	1	MI
Bearing Set, Conn Rod	A-U5ME0003C	.030	1	MI

DESCRIPTION	PART NO	SIZE	QTY	KIT
Washer Set, Thrust (4)	A-31137551/61	STD	1	M

DESCRIPTION	PART NO	SIZE	QTY	KIT
Seal, Front Crankshaft	A-2418F436		1	M
Seal, Rear Crankshaft	A-303158411		1	M
Camshaft Kit	A-ZZ90085		1	

DESCRIPTION	PART NO	SIZE	QTY	KIT
Valve Train Kit	A-VTK613		1	M
Valve, Intake ¹	A-3142L071		6	
Valve, Exhaust	A-3142A051		6	
Guide, Intake Valve	A-3343F002		6	
Guide, Exhaust Valve	A-3343J002		6	
Spring, Valve Inner	A-31744133		12	
Spring, Valve Outer	A-31745122		12	
Seal, Valve	A-33817117		12	
Keeper, Valve	A-33173108		12	



DESCRIPTION	PART NO	SIZE	QTY	KIT
Bushing, Conn Rod	A-31134131		6	M
Bolt, Conn Rod	A-4222485M1		12	MI
Nut, Conn Rod	A-33221328		12	MI
Rod, Connecting (Turbo) ²	A-ZZ90013		6	
Connecting Rod ²	A-ZZ90058		6	

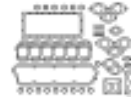

DESCRIPTION	PART NO	SIZE	QTY	KIT
Gasket, Upper Set	A-U5LT0179		1	MI
Gasket, Lower Set w/o Seal	A-U5LB0153		1	MI
Gasket, Head	A-3681H205		1	



DESCRIPTION	PART NO	SIZE	QTY	KIT
Camshaft	A-31416307		1	
Tappet	A-31434163		12	
Rod, Push	A-31434307		12	
Rocker Arm, LH	A-41151483		6	
Arm, RH Rocker	A-41151484		6	
Bushing, Rocker Shaft	A-2511425		12	



DESCRIPTION	PART NO	SIZE	QTY	KIT
Pump, Oil	A-4132F057		1	
Pump, Fuel Lift Transfer	A-2641729		1	



DESCRIPTION	PART NO	SIZE	QTY	KIT
Assembly Lube; 8oz	A-10152		1	
Assembly lube; Case of 12-8oz bottles	A-10153		1	

Parts are not original equipment parts and are not sponsored, affiliated, or otherwise connected with any major brand.

1) 45 degree angle 2) check w/ build list

Parts are not original equipment parts and are not sponsored, affiliated, or otherwise connected with any major brand.

ENGINE INFORMATION

1006.60T Diesel

TURBOCHARGED ^ 6 CYL, LIP SEAL

BORE: 3.9370" 100.00mm



DESCRIPTION	PART NO.
MAJOR OH KIT	A-OK515
IN FRAME OH KIT	A-IK515

For Models: (TRACTOR: 3625 E-SN 557976X>, 3660 With Engine Build# YB31263)

ENGINE COMPONENT PARTS

NOTICE: Parts included in the overhaul kits are indicated as follows:

M parts included in MAJOR OVERHAUL KITS

I parts included in IN FRAME OVERHAUL KITS

DESCRIPTION	PART NO	SIZE	QTY	KIT
Piston Liner Kit	A-U5MK0275		6	MI
Piston	A-U5LL0014		6	
Liner, Cylinder	A-3135X042		6	
Rings, Piston	A-4181A026		6	

DESCRIPTION	PART NO	SIZE	QTY	KIT
Bearing Set, Main (7)	A-U5MB0007	STD	1	M
Bearing Set, Main (7)	A-U5MB0007A	.010	1	M
Bearing Set, Main (7)	A-U5MB0007B	.020	1	M
Bearing Set, Main (7)	A-U5MB0007C	.030	1	M

DESCRIPTION	PART NO	SIZE	QTY	KIT
Bearing Set, Conn Rod	A-U5ME0003	STD	1	MI
Bearing Set, Conn Rod	A-U5ME0003A	.010	1	MI
Bearing Set, Conn Rod	A-U5ME0003B	.020	1	MI
Bearing Set, Conn Rod	A-U5ME0003C	.030	1	MI

DESCRIPTION	PART NO	SIZE	QTY	KIT
Washer Set, Thrust (4)	A-31137551/61	STD	1	M

DESCRIPTION	PART NO	SIZE	QTY	KIT
Seal, Front Crankshaft	A-2418F436		1	M
Seal, Rear Crankshaft	A-303158411		1	M
Camshaft Kit	A-ZZ90085		1	

DESCRIPTION	PART NO	SIZE	QTY	KIT
Valve Train Kit	A-VTK614		1	M
Valve, Intake ¹	A-3142L072		6	
Valve, Exhaust	A-3142A051		6	
Guide, Intake Valve	A-3343F002		6	
Guide, Exhaust Valve	A-3343J002		6	
Spring, Valve Inner	A-31744133		12	
Spring, Valve Outer	A-31745122		12	
Seal, Valve	A-33817117		12	
Keeper, Valve	A-33173108		12	

1006.60T Diesel

DESCRIPTION	PART NO	SIZE	QTY	KIT
Bushing, Conn Rod	A-31134131		6	M
Bolt, Conn Rod	A-4222485M1		12	MI
Nut, Conn Rod	A-33221328		12	MI
Rod, Connecting (Turbo) ²	A-ZZ90013		6	
Connecting Rod ²	A-ZZ90058		6	

DESCRIPTION	PART NO	SIZE	QTY	KIT
Gasket, Upper Set	A-U5LT0179		1	MI
Gasket, Lower Set w/o Seal	A-U5LB0153		1	MI
Gasket, Head	A-3681H205		1	

DESCRIPTION	PART NO	SIZE	QTY	KIT
Camshaft	A-31416307		1	
Tappet	A-31434163		12	
Rod, Push	A-31434307		12	
Rocker Arm, LH	A-41151483		6	
Arm, RH Rocker	A-41151484		6	
Bushing, Rocker Shaft	A-2511425		12	

DESCRIPTION	PART NO	SIZE	QTY	KIT
Pump, Oil	A-4132F057		1	
Pump, Fuel Lift Transfer	A-2641729		1	

DESCRIPTION	PART NO	SIZE	QTY	KIT
Assembly Lube; 8oz	A-10152		1	
Assembly lube; Case of 12-8oz bottles	A-10153		1	

- ALLIS CHALMERS
- CASE-IH
- CATERPILLAR
- CLARK
- DEUTZ
- FIAT
- FORD / NEW HOLLAND
- GEHL
- HYSTER
- IMT
- INGERSOLL RAND
- JACOBSEN
- JCB
- JOHN DEERE
- LANDINI
- LEYLAND
- LINCOLN ELECTRIC
- MASSEY FERGUSON
- MELROE
- MICHIGAN
- OWATTONA
- PERKINS USA
- RENAULT
- SULAIR CORP
- VERMEER
- WHITE/ OLIVER
- ZETOR

1) 30 degree angle 2) check w/ build list

V8.540 Diesel

ENGINE INFORMATION

V8.540 Diesel

8 CYL, LIP SEAL

BORE: 4.25" 107.95mm



DESCRIPTION	PART NO.
MAJOR OH KIT- N/A	A-OK800
IN FRAME OH KIT (N/A)	A-IK800

For Models: (TRACTOR: 1155, 2745), (COMBINE: 760, 860)

ENGINE COMPONENT PARTS

NOTICE: Parts included in the overhaul kits are indicated as follows:

M parts included in MAJOR OVERHAUL KITS

I parts included in IN FRAME OVERHAUL KITS



DESCRIPTION	PART NO.	SIZE	QTY	KIT
Piston Liner Kit	A-U5MK0073		8	
Piston	A-92508		8	
Liner, Cylinder	A-31358126		8	
Rings, Piston	A-41158137		8	



DESCRIPTION	PART NO.	SIZE	QTY	KIT
Bearing Set, Main ¹	A-84952	Std	1	
Bearing Set, Main ¹	A-84952A	.010	1	



DESCRIPTION	PART NO.	SIZE	QTY	KIT
Bearing, Conn Rod	A-U5ME0001	Std	8	
Bearing, Conn Rod	A-U5ME0001A	.010	8	



DESCRIPTION	PART NO.	SIZE	QTY	KIT
Seal, Front Crankshaft	A-2418F436		1	
Seal, Rear Crankshaft	A-303158411		1	
Viton				



DESCRIPTION	PART NO.	SIZE	QTY	KIT
Valve, Intake	A-31431822		8	
Valve, Exhaust	A-31431385		8	
Guide, Intake & Exhaust Valve	A-33431505		16	

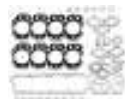

DESCRIPTION	PART NO.	SIZE	QTY	KIT
Gasket, Head	A-69042		1	
Gasket, Lower Set	A-U5LB0027		1	
Gasket, Head	A-3681H401		2	



DESCRIPTION	PART NO.	SIZE	QTY	KIT
Tappet	A-31434163		16	



DESCRIPTION	PART NO.	SIZE	QTY	KIT
Pump, Oil	A-41314159		1	



DESCRIPTION	PART NO.	SIZE	QTY	KIT
Assembly Lube; 8oz	A-10152		1	
Assembly lube; Case of 12-8oz bottles	A-10153		1	

Parts are not original equipment parts and are not sponsored, affiliated, or otherwise connected with any major brand.

¹) Thrust Washer Not Available

Engine Related Parts

Parts are not original equipment parts and are not sponsored, affiliated, or otherwise connected with any major brand.

A-3637331M1 Liner, Cylinder (Semi-Finished) 2.03 Lbs.



For Models: 1007, 174-4S, 3065, 3070, 362, 365, 372, 373, 375, 377, 383, 387, 390T, 398, 50E, 50EX, 50H, 50H SERIES S, 50HX, 50HX SERIES S, 60H

A-31358393 Liner, Cylinder (Semi-Finished) 3.55 Lbs.



For Models: 168, 174-4S SN: LD31178, LD31179, LF31178, LF31164, LF31180, 175 UK, 274, 399, 560, 565, 575, 675, 698T, 699, 1134, 2620, 2640, 2645, 2680, 2685, 2720, 2725, 3050, 3080, 3090, 3630, 30D, 31, 500, 50B MKII, 50D, (50E, 50EX ALL SN: LD31114, LD31132, LD31163), (50H, 50HX ALL SN: < U106654N), 60H OD: 103.250MM, 27, (COMBINE: 29, 29XP, 31XP, 510, 515, 520, 525, 530, 535, 660, 665, 800, 805, 820, 825, 830, 835)

A-734644M1 Liner, Cylinder (Semi-Finished) 2.03 Lbs.



For Models: 520, 525

A-3135X033 Liner, Cylinder (Semi-Finished) 4.248 Late0.00 Lbs.



For Models: 382, 382N SN: B18009 >, 390, 393, 397, 3060, (4235, 4240 ALL W/ BUILD PREFIX: LM), (50H, 50HX, 60H ALL BUILD NO'S: LF31130, LF31164, LF31180), 6110, 6120

A-739475M1 Pulley, Crankshaft (Single Groove) 8.38 Lbs.
Replaces: Perkins# 31148924



Dim/Info:
Single Groove

For Models: 1080, 70 ENGINE SN <318UA1503

A-303158411 Seal, Rear Crankshaft Viton 0.32 Lbs.



Dim/Info:
5.394" X 6.260" X .433"
LIP TYPE SEAL

For Models: 253, 1007, 3065, 3070, 390T, 398, 135, 148, 152, 230, 240, 250, 254, 255, 350, 565, 575, 590, 1080, 298, 698, 520, 525, 1200, 535, 625, 3075, 4245, 4255, 6140, 6150, 3095, 399, 4260, 4270, 6170, 3120, 3120T, 3125, 3140, 3645, 3655, 3660, 6180, 6190, 8120, 4225, 4235

A-4223519M1 Guide, Valve 0.02 Lbs.
Replaces: 0420002, 420002, 731126M1

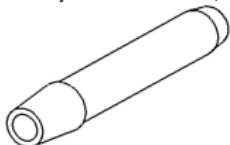

Dim/Info:
2 19/32" Long

For Models: FE35 SN <1846219 W/ A3.152 ENGINE, 35 W/ A3.152 ENGINE, 65 W/ REGULAR DIESEL ENGINE

A-731153M1 Spring, Valve Inner (8 pack) 0.07 Lbs.



For Models: 352 used w/ 3637523M91, 35FE, 65, 92

A-1476232 Nut, Cylinder Head (318) 0.06 Lbs.
Replaces: 376672

For Models: (1080, 285 ALL W/ A4.318 ENGINE)

A-3640877M91 Head, Cylinder 80.00 Lbs.
Replaces: 737772M1, 742803M91, 742805M91, 748400M91, 3637486M91

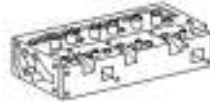

For Models: (165, 50, 50B ALL W/ A4.212 ENGINE), (168, 174-4S, 175, 240, 265, 274, 275, 30D, 3050, 362, 365, 372, 373, 375, 377, 383, 387, 50B MKII, 50D, 50E, 50EX, 50H, 50H SERIES S, 50HX, 50HX SERIES S, 565, 575, 60H, 675 ALL W/ A4.236 ENGINE), (178, 185, 188, 285, 290, 3060, 382, 390, 393, 397, 590, 60H SERIES S, 690 ALL W/ A4.248 ENGINE)

A-3638321M91 Head, Cylinder 46.00 Lbs.
Replaces: ZZ80058, 68131, U5BD0024, 731781M91



For Models: 35 W/ A3.152 ENGINE

A-737225M1 Gasket, Head Cover 0.14 Lbs.

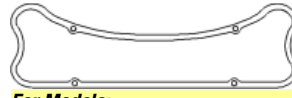

For Models:

A-732821M1 Gasket, Head Cover 0.40 Lbs.



For Models: (155, 158, 165, 260, 50, 560 UK, 65, 765 ALL W/ AD4.203 ENGINE)

A-748329M1 Gasket, Head Cover 0.15 Lbs.

For Models: 3085, 3095, 3115, 3120, 3120T, 3125, 3140, 3645, 3655, 3660, 399, 6160, 6170 S/N <F014037, 6180 S/N <F017008, 6190, 8110, 8120 S/N <F044008, 8130

A-3638772M1 Gasket, Pan 0.22 Lbs.
Replaces: 740676M1



For Models: (1105, 1135 ALL W/ AT6.354.1 ENGINE), (1134, 2680, 2685, 2720, 2725, 3630, 3650, 565, 560 UK, 660 UK, 665, 750, 820, 825, 830, 835, 840, 845 ALL W/ AT6.354.4 ENGINE), (1100, 500, 510, 515, 520, 525 ALL W/ A6.354 ENGINE), 1200 W/ A6.354.1 ENGINE, (1014, 1114, 1250, 2620, 2640, 2645, 3090, 399, 699, 3080, 24, 27, 535, 530, 805 ALL W/ A6.354.4 ENGINE), (620, 625, 750 ALL W/ A6.372.1 ENGINE)







A-3638519M1 Gasket, Pan 0.01 Lbs.
Replaces: 746425M1

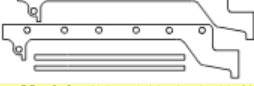

For Models: 1007, 165, 168, 174, 174-4S, 175, 178, 185, 188, 265, 274, 275, 285, 290, 3050, 3060, 3065, 3070, 3075, 30D, 362, 365, 372, 373, 375, 377, 382, 383, 387, 390, 390T, 393, 397, 398, 50, 50B, 50D, 50E, 50EX, 50H, 50H SERIES S, 50HX, 50HX SERIES S, 565, 575, 590, 60H, 60H SERIES S, 6110, 6120, 6130, 6140, 6150, 675, 690, 698T

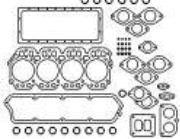
- ALLIS CHALMERS
- CASE-IH
- CATERPILLAR
- CLARK
- DEUTZ
- FIAT
- FORD / NEW HOLLAND
- GEHL
- HYSTER
- IMT
- INGERSOLL RAND
- JACOBSEN
- JCB
- JOHN DEERE
- LANDINI
- LEYLAND
- LINCOLN ELECTRIC
- MASSEY FERGUSON
- MELROE
- MICHIGAN
- OWATTONA
- PERKINS USA
- RENAULT
- SULAIR CORP
- VERMEER
- WHITE/ OLIVER
- ZETOR

Engine Related Parts

ALLIS CHALMERS	A-VPC5346	Gasket, Pan Set	0.16 Lbs.
	FOR MODELS W/ ROPE TYPE SEAL (SET CONTAINS: 1-748307M91, 1-736242M1 & 1-734952M91 GASKETS)		
CASE-IH	<i>Replaces:</i> 748307M91, 736242M1, 734952M91		
CATERPILLAR			
CLARK	<i>For Models:</i> (135, 148, 254, 40 ALL SN <152UA391044D W/ AD3.152 ENGINE), 35 W/ A3.152 ENGINE		
DEUTZ	A-VPC5347	Gasket, Pan Set	0.16 Lbs.
	FOR MODELS W/ LIP TYPE SEAL (KIT CONTAINS: 1-748307M91, 1-748306M1 & 1-4222056M91 GASKETS)		
FIAT	<i>Replaces:</i> 748307M1, 748306M1, 4222056M91, 741632M91		
FORD / NEW HOLLAND			
GEHL	<i>For Models:</i> (135, 40 ALL SN 152UA391045DL> W/ AD3.152 ENGINE), 35 W/ A3.152 ENGINE, (20B, 20D, 20E, 20F, 230, 250, 255, 30E, 30H, 340, 342, 350, 353, 355, 550 ALL W/ AD3.152 ENGINE), (360, 363, 40E, 352, 355 ALL W/ AT3.152.4 ENGINE)		
HYSTER	A-3641224M1	Gasket, Rear Main Housing	0.04 Lbs.
	<i>Replaces:</i> 740828M1, 3638520M1		
IMT		<i>Dim/Info:</i> 10/PACKAGE	
INGERSOLL RAND	<i>For Models:</i> 1014, 1114, 1134, 1200, 1250, 168, 175, 178, 185, 188, 240, 2620, 2640, 2645, 265, 2680, 2685, 2720, 2725, 274, 275, 285, 290, 30D, 3050, 3060, 3065, 3070, 3075, 3085, 3090, 3095, 31, 3115, 3120, 3125, 3140, 362, 3630, 3645, 365, 3650, 3655, 3660, 372, 373, 375, 377, 382, 383, 387, 390, 390T, 393, 397, 398, 399, 50, 50B, 50B MKII, 50D, 50E, 50H, 50H SERIES S, 50HX, 50HX SERIES S, 565, 575, 590, 60H, 60H SERIES S, 6140, 6150, 6180, 6190, 690, 699, 8120, 8937, 6170 SN <F014037		
JACOBSEN	A-1810028M91	Gasket, Upper Set	1.05 Lbs.
	<i>Replaces:</i> 827561M92		
JOHN DEERE			
LANDINI	<i>For Models:</i> 35X, FE35, T035		
LEYLAND	A-731354M1	Plug, Freeze (1.25")	0.04 Lbs.
LINCOLN ELECTRIC	<i>Dim/Info:</i> 1.250" Cup Type Plug		
MASSEY FERGUSON			
MELROE	<i>For Models:</i> SEVERAL		
MICHIGAN	A-735944M1	Plug, Freeze (1.391")	0.04 Lbs.
	<i>Replaces:</i> 376190X1, 0650618, 32418117		
OWATTONA		<i>Dim/Info:</i> 1 25/64" Cup Type	
	<i>For Models:</i> SEVERAL		
PERKINS USA	A-735742M1	Washer Set, Thrust (.007")	0.22 Lbs.
RENAULT			
SULAIR CORP	<i>For Models:</i> 1007, 1014, 1080, 1100, 1114, 1134, 1200, 1250, 165, 175, 178, 185, 188, 2620, 2640, 2645, 265, 2680, 2685, 2720, 2725, 274, 285, 290, 298, 3050, 3060, 3065, 3070, 3080, 3085, 3090, 3095, 30D, 3115, 3120, 3120T, 3125, 3140, 362, 3630, 3635, 3645, 365, 3655, 3660, 372, 373, 375, 377, 382, 383, 387, 390, 390T, 393, 397, 398, 399, 4225, 4235, 4240, 4245, 4255, 4260, 4270, 4325, 4335, 4345, 4355, 4360, 4370, 50B, 50B MKII, 50D, 50E, 50EX, 50H, 50H SERIES S, 50HX, 50HX SERIES S, 565, 575, 590, 595, 6		
VERMEER			
WHITE/OLIVER			
ZETOR			

A-3A73FS Gasket, Overhaul Set 1.00 Lbs.

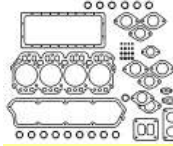

For Models: (35, 50 ALL Eng. SN <1935853)

A-745764M91 Rings, Piston 0.20 Lbs.

Replaces: 740083M91, 745790M91, 41158045, 86775



For Models: (165, 50B ALL <212UA147671 And 212UA087001>)

A-31358343 Liner, Cylinder (Semi-Finished) 4.248 2.85 Lbs.



Dim/Info:
Bore Dia.: 3.95"
Outside Dia.: 4.063"
Overall Height: 8.803"

For Models: (TRACTOR: 178 UK, 185, 188)

A-3A72FS Gasket, Overhaul Set 1.93 Lbs.

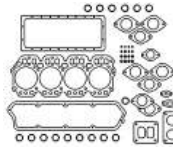

For Models: (1080, 1085, 285, 540 ALL Regular Injection)

A-VPA6001 Valve Train Kit 2.21 Lbs.



For Models: (35FE, 35X ALL <1935853)

A-743029M91 Gasket, Pan Set 0.74 Lbs.



For Models: 65, 765

A-746050M91 Gasket, Upper Set 0.90 Lbs.

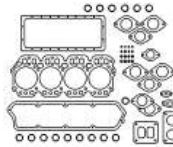

For Models: 65, 765

A-740082M91 Piston 3.61 Lbs.



For Models: (50, 50B ALL 212UA087001 - 212UA147671)

A-746163M91 Rings, Piston 0.21 Lbs.



For Models: (298, 698 ALL w/ A4.318.2)

Parts are not original equipment parts and are not sponsored, affiliated, or otherwise connected with any major brand.

Engine Related Parts

Parts are not original equipment parts and are not sponsored, affiliated, or otherwise connected with any major brand.

A-VPA6003 Valve Train Kit 2.18 Lbs.



For Models: 40

A-740760M91 Cover, Valve 2.50 Lbs.
Used on Perkins A3.152 Gas & AD3.152, T3.152.4 Diesel Engines
Replaces: Perkins# 37188571

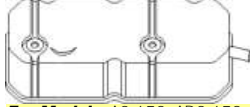

For Models: A3.152, AD3.152, D3.152, (135, 150 ALL W/ Perkins Dsl. Eng. SN 152UA340545D>), (135, 150 ALL W/ Perkins Gas Eng. SN 152UA25847A>), 230, 231, 235, 240, 240P, 240S, 245, 250, 253, 263, 360, 20 W/ Perkins Dsl. Eng. SN 152UA340545D>, 20 W/ Perkins Gas Eng. SN 152UA25847A - 152UA26775A, 20C, 20D, 20E, 20F, 30B, 30D, 30E, 30H, 40 W/ Perkins Dsl. Eng. SN 152UA34054DL>, 40E, 2500 Forklift W/ Perkins Dsl. Eng. SN 152UA340545D>

A-747198M91 Gasket, Lower Set 0.67 Lbs.

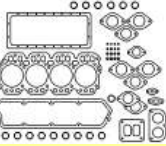

For Models: 2680 < S271212, 31

A-3637075M91 Idler Gear 5.00 Lbs.
Replaces: 734738M91, 4111A013, 41115023

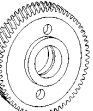

Dim/Info:
63 Tooth

For Models: 165, 174-4S, 175, 180, 184-4, 24, 25, 255, 261, 265, 270, 274-4, 275, 282, 283, 285, 290, 294-4, 30, 3050, 3060, 3065, 3070, 3075, 3095, 31, 3120, 3120T, 3125, 3140, 362, 3645, 365, 3655, 3660, 374S, 374V, 375, 383, 390, 396, 398, 399, 4225, 4235, 4240, 4260, 4263, 4270, 4360, 4370, 50C, 50D, 50E, 50F, 50H, 60, 60H, 6140, 6150, 6170, 6180, 6190, 6270, 6280, 6290, 6500, 6500H, 670, 6800H, 690, 8120, 8210, 8220

A-731011M1 Gasket, Head 0.50 Lbs.

For Models: 65 W/ Regular Diesel

A-3638780M1 Gasket, Rear Main Housing 0.05 Lbs.
Replaces: 735110M1, Perkins# 36817136

For Models: 1100, 1130, 165, 174-4S, 175, 180, 184-4, 220, 255, 265, 270, 274-4, 275, 282, 283, 290, 294-4, 30, 31, 50C, 50D, 50E, 60, 6500, 670, 690, 80

A-4222128M1 Liner, Cylinder 2.65 Lbs.



For Models: 271, 281, 4260 W/ Build Prefix YG, 4263, 4270 W/ Build Prefix YH, 4360, 4370, 6170 S/N F014038>, 6180 S/N F017009>, 6235, 6245, 6255, 6265, 6270, 6280, 6290, 8120 S/N F044009>, 8210, 8220

A-745243M1 Liner, Cylinder (Semi-Finished, .010") 1.97 Lbs.
Replaces: 31358384



Dim/Info:
Bore Dia.: 3.565"
Outside Dia.: 3.698"
Overall Height: 8.495"
Flange Dia.: 3.806"
Flange Width: .149"
Dry Type

For Models: 35 W/ A3.152 Engine, SN 1935854>, 65 W/ AD4.203 Engine, SN 2939037>, (135, 148, 230, 240, 250, 254, 255, 340, 342, 350 ALL W/ AD3.152 Engine), (50, 155, 158, 165, 260, 560, 765 ALL W/ AD4.203 Engine), 363 W/ AT3.152.4 Engine, (20D, 20E, 20F, 30E, 30H, 40, 550 ALL W/ AD3.152 Engine)

A-W2004SA Washer Set, Thrust (Std) 0.12 Lbs.



For Models: 2080, 2085

A-W2034L Washer Set, Thrust (Std) 4.23 Lbs.

For Models: FE35

A-736502M1 Seal, Exhaust Valve 0.00 Lbs.
Replaces: 33152139

For Models: 1085, 1100, 1130, 1135, 174-4S, 175, 180, 255, 265, 270, 274-4, 285, 294-4, 3090, 31, 362, 50C, 50D, 50E, 510, 540, 670, 699, 750, 760

A-1446022M91 Seal, Valve, 3.152/4.203 0.01 Lbs.

For Models: (135, 148, 150 ALL AD3.152 Engine), (155, 158, 165 ALL AD4.203 Engine), (20D, 20E, 20F, 230, 240, 250 ALL AD3.152 Engine), 253 AT3.152.4 Engine, (254, 255, 30E, 30H, 340, 342 ALL AD3.152 Engine), 35 A3.152 Engine, 350 AD3.152 Engine, 352 AT3.152.4 Engine, 353 AD3.152 Engine, (355, 360, 363 ALL AT3.152.4 Engine), 40 AD3.152 Engine, 40E AT3.152.4 Engine, 50 AD4.203 Engine, 550 AD3.152 Engine, (560, 65 ALL AD4.203 Engine), 65 A4.192 Engine, 765 AD4.203 Engine, 765 A4.192 Engine

A-V10015 Spring, Valve (2085) 0.00 Lbs.



For Models: 2085

A-31744131 Spring, Inner Valve 0.07 Lbs.
For A4.236 Engine
Replaces: 31744127

For Models: 270, 274-4, 362, 365, 375, 50C, 50D, 50E, 50H, 50HX, 60H, 670

A-731999M1 Plug, Freeze (.891") 0.02 Lbs.
Replaces: 0650664



Dim/Info:
57/64" Cup Type

For Models: 1150, 1155, 135, 150, 154-4, 154-4S, 20, 203, 205, 20C, 2135, 2200, 230, 235, 245, 250, 254-4, 2675, 2705, 2745, 30D, 35, 40, 540, 750, 760, 850, 860

A-746259M1 Plug, Freeze (1.505") 0.06 Lbs.











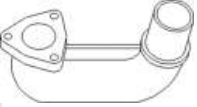
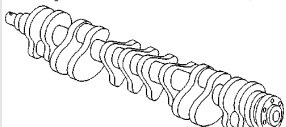
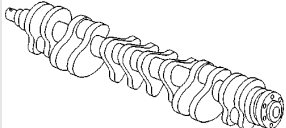

Dim/Info:
1.505" O.D.

For Models: FITS SEVERAL MODELS

- ALLIS CHALMERS
- CASE-IH
- CATERPILLAR
- CLARK
- DEUTZ
- FIAT
- FORD / NEW HOLLAND
- GEHL
- HYSTER
- IMT
- INGERSOLL RAND
- JACOBSEN
- JCB
- JOHN DEERE
- LANDINI
- LEYLAND
- LINCOLN ELECTRIC
- MASSEY FERGUSON
- MELROE
- MICHIGAN
- OWATTONA
- PERKINS USA
- RENAULT
- SULAIR CORP
- VERMEER
- WHITE/ OLIVER
- ZETOR

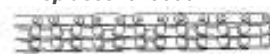
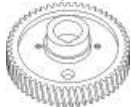
Engine Related Parts

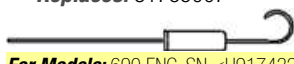
ALLIS CHALMERS	A-4222043M1	Plug, Freeze (2")	0.06 Lbs.
CASE-IH		<i>Dim/Info:</i> 1.975" O.D.	
CATERPILLAR	<i>For Models:</i> FITS SEVERAL MODELS		
	A-31431385	Valve, Exhaust	0.30 Lbs.
	<i>Replaces:</i> 739374M1, 31431385		
CLARK			
DEUTZ			
FIAT	<i>For Models:</i> (TRACTOR: 1150, 1155, 2745), (COMBINE: 760, 860, 865)		
FORD / NEW HOLLAND	A-836427M1	Gasket, Front Cover Set with Front & Rear Oil Seals	0.64 Lbs.
	<i>For Models:</i> 135, 150, TE20, TO20, TO30		
GEHL	A-376525X1	Sleeve, Fuel Line (10 pack)	0.05 Lbs.
HYSTER	<i>For Models:</i> 1080, 1085, 1100, 1105, 1130, 1135, 130, 135, 135 UK, 150, 154-4, 154-4S, 165, 165 UK, 174-4S, 175, 175 UK, 180, 184-4, 20, 20D, 20E, 20F, 2135, 2200, 231, 235, 240, 240P, 240S, 245, 250, 253, 254-4, 255, 261, 263, 2640, 265, 265S, 2675, 270, 2705, 271, 274-4, 275, 275 UK, 281, 281XE, 282, 283, 283 UK, 285, 285S, 290, 290 UK, 294-4, 298, 30, 3050, 3060, 3065, 3070, 3075, 3090, 3095, 30B, 30E, 30H, 31, 3120, 3120T, 3125, 3140, 3505, 3525, 3545, 360, 362, 3630, 3645, 365 SN: < R18009, 3650, 3655,		
IMT			
INGERSOLL RAND	A-3300940M1	Elbow, Exhaust	5.71 Lbs.
JACOBSEN			
JCB	<i>For Models:</i> 154-4S, 174-4S, 184-4, 194-4, 274-4, 294-4, 374S, 374V, 384S, 394S		
JOHN DEERE	A-ZZ90116	Crankshaft	46.69 Lbs.
	Uses 2 piece rope seal. <i>Replaces:</i> 3638309M91, 3637454M1, 31312436		
LANDINI			
LEYLAND			
LINCOLN ELECTRIC	<i>For Models:</i> (ENGINE: D3.152, 3.152), 35 UTILITY, 235 W/ PERKI<152UA381043DL 3.152 DIESEL ENGINE SN ENDING W/ DS, (20, 35, 40, 50, 135, 150, 2244 ALL W/ PERKINS A3.152 OR AD3.152 ENGINE SN <152UA381043DL), (203, 205, 2135 ALL W/ PERKINS A3.152 OR AD3.152 DIESEL ENGINE SN ENDING W/ DS), 2500		
MASSEY FERGUSON	A-3637410M91	Crankshaft	51.00 Lbs.
MELROE	Uses 1 piece seal. <i>Replaces:</i> 742827M1, U5BG0027		
MICHIGAN		<i>Dim/Info:</i> Used on build CE95231	
OWATTONA			
PERKINS USA	<i>For Models:</i> 250, 40, 235 ENG SN ENDING IN DL, (135, 20, 20C, 200 SERIES, 230, 245, 2500, 255, 30B, 4500 ALL W/ AD3.152 DIESEL ENGINE SN 152UA391044DL >)		
RENAULT	A-825740M1	Seal, Crankshaft, Front	0.18 Lbs.
	<i>Replaces:</i> 104662		
SULAIR CORP			
VERMEER	<i>For Models:</i> FE35, TEA20, TED20, TEF20, TO35, 135 UK, 35X		
WHITE/OLIVER			
ZETOR			

A-015287A	Seal, Crankshaft, Front	0.17 Lbs.
	<i>Dim/Info:</i> (473467)	
<i>For Models:</i> F40, 135, 150, TE20, TO20, TO30, TO35, 202, 204, 35, 50		
A-0410132	Gear, Crankshaft (3.152)	1.23 Lbs.
<i>Replaces:</i> 731228M1, 3641397M91, 3641826M1		
	<i>Dim/Info:</i> Not used on build no CE95231	
<i>For Models:</i> 150, 20, 220, 2500, 35 UTILITY, 40, 50, (135, 148, 230, 240, 250, 253, 254, 255, 35, 363, 550 ALL W/ A3.152, AD3.152 OR AT3.152 PERKINS ENGINES)		
A-825199M1	Chain, Timing	0.98 Lbs.
<i>Replaces:</i> 825886M1		
		
<i>For Models:</i> 135 UK MODEL W/ 87MM ENGINE, TE20 W/ 80MM OR 85MM ENGINE, FE35 W/ 87MM ENGINE		
A-3641740M1	Gear, Camshaft	3.79 Lbs.
<i>Replaces:</i> 3641739M1, 748182M1, 3117L011		
	<i>Dim/Info:</i> 56 Tooth	
<i>For Models:</i> 265S, 271, 3050, 3070, 3095, 3120, 3120T, 3125, 3140, 374S, 374V, 384S, 394S, 4225, 4235, 4240, 4243, 4245, 4253, 4255, 4265, 4325, 4335, 4345, 4355, 6235, 6245, 174-4S ENG. SN U08337N>, 3065 ENG. SN U083372N>, (3060, 50H, 50HX, 60H ALL ENG. SN U108197N>), 50E POWER SHUTTLE, 6180 SN <F017008 US MODEL ONLY, 294-4 SN 223D02348>, (275, 283, 290 ALL UK MODEL ONLY)		
A-636762M1	Seal, Tach Drive	0.02 Lbs.
<i>For Models:</i> (135, 148, 20B, 20D, 20E, 20F, 230, 240, 250, 254, 255, 30E, 30H, 35, 350, 40, 40E, 550 ALL IND. W/ A3.152 OR AD3.152 PERKINS ENGINE), (15, 158, 165, 260, 50, 65, 765 ALL IND. W/ A4.192 OR AD4.203 PERKINS ENGINE)		
A-41314078	Pump, Oil w/ Gaskets	4.23 Lbs.
<i>Replaces:</i> 3638632M91, 1641076M91, 41314187		
		
<i>For Models:</i> 135, 150, 154-4, 154-4S, 20, 20D, 20F, 200 SERIES, 203, 205, 220, 2244, 2500, 254-4, 30E, 30H, 35, 35 UTILITY, 40, 4500, 4830FC, 50, 5500, 5830, 5830FC, 6030FC		
A-835643M1	Kit, Oil Pump	0.78 Lbs.
		
<i>For Models:</i> (202, 204, 20C, 2200, 230, 235, 245, 2500, 30B, 35, 4500, 50, TE20, TO20, TO30, TO35 ALL Gas)		
A-742991M91	Dipstick, Oil	0.06 Lbs.
<i>Replaces:</i> 31785007		
		
<i>For Models:</i> 690 ENG. SN <U917432, 290 ENG. SN <U917432K		
A-747476M91	Dipstick, Oil	0.08 Lbs.
		
<i>For Models:</i> 382N SN B18009> W/ A4.248 ENGINE, (1007, 3065, 3070, 390T, 393, 398, 698T ALL W/ AT4.236 ENGINE), (3050, 362, 365, 372, 375 ALL W/ A4.236 ENGINE), (3060, 382, 383, 390 ALL W/ A4.248 ENGINE)		

Parts are not original equipment parts and are not sponsored, affiliated, or otherwise connected with any major brand.

Parts are not original equipment parts and are not sponsored, affiliated, or otherwise connected with any major brand.

A-1750216M1 Seal, Rear Main 0.28 Lbs.



For Models: F40, 135, 150, TE20, TO20, TO30, TO35, 202, 204, 3165, 35, 50, 65

A-746697M1 Bearing, Balancer Unit 0.25 Lbs.

For Models: (174-4S, 265, 274, 275, 30D, 50D, 565, 575, 675 ALL SN <880190K W/ A4.236 PERKINS ENGINE), (285, 290, 590, 690 ALL SN <880190K W/ A4.248 PERKINS ENGINE), (168, 175, 50, 50B ALL W/ A4.236 PERKINS ENGINE), (178, 185, 188 ALL W/ A4.248 PERKINS ENGINE), 60H W/ BUILD #'S LF31128, 31135, 31180 W/ A4.248 PERKINS ENGINE

A-32731115 Shaft, Balancer 1.50 Lbs.



For Models: (175, 178 ALL UK MODEL W/ A4.236 ENGINE SN <236UA10155)

A-ZZ90010 Connecting Rod, 8.875" Center to Center 3.49 Lbs.



For Models: 365 E-SN <2939035 NOT ENDING W/ DL, (300, 3165, 356, 40B, 50 ALL E-SN 29C1085>), 304 E-SN 2939036-29C1084, (20C, 235, 245, 30B ALL ENG SN ENDING IN DS), 40 INDUSTRIAL W/ AD3.152 & AT3.152 ENGINES, (135, 148, 20B, 20D, 20E, 20F, 230, 240, 250, 253, 254, 255, 30E, 30H, 350, 353, 355, 360, 363, 40E, 550 ALL W/ AD3.152 & AT3.152 ENGINES), (155, 158, 165, 260, 560 UK, 65, 765 ALL W/ AD4.203 ENGINE)

A-4222485M1 Bolt, Connecting Rod 0.20 Lbs.
For models w/ Perkins A4.212, A4.236, AT4.236, A4.248, A6.354, AT6.354 & A6.372 Engines.

A-1476232X1 Nut, Cylinder Head 0.06 Lbs.

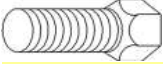

For Models: 1007, 1014, 1100, 1114, 1134, 1200, 1250, 165, 168, 174, 175, 178, 184, 185, 188, 2620, 2640, 2645, 2680, 2685, 2720, 2725, 274, 275, 285, 290, 3050, 3060, 3065, 3070, 3080, 3090, 3095, 30D, 3115, 3125, 362, 3630, 3645, 365, 3650, 3655, 373, 375, 377, 383, 387, 390, 390T, 393, 397, 398, 399, 50, 50B, 50E, 565, 575, 590, 60H, 675, 690, 698T, 699

A-731356M1 Freeze Plug, Cylinder Block 0.02 Lbs.
Replaces: 72080009, 159312A



For Models: 135, 135 UK, 150, 154-4, 154-4S, 165, 165 UK, 230, 231, 235, 240, 240P, 245, 250, 253, 254-4, 255, 263, 285, 298, 35, 35 TURF, 35 UTILITY, 35FE, 35X, 399, 50 MASSEY HARRIS, 65, 364S S/N <D03066, 698, 699, SUPER 90, 1080, 1085, 1100, 1105, 1130, 1135, 2640, 2675, 2705, 3090, 3165, 3505, 3525, 3545, 3630, 3650, 20, 20C, 20D, 20F, 30, 30B, 30D, 30E, 40, 40B, 50, 50A, 70, 80, 200 SERIES, 302, 304, 2135, 2200, 2500, 4500, 300, 320, 410, 510, 540, 550, 750, 760, 850, 860, 92SP

A-744779M91 Flywheel Less Ring Gear 80.00 Lbs.
Replaces: (Perkins# 41117221)



For Models: 2675, 2705

A-825452M1 Flywheel w/ Ring Gear 4.00 Lbs.



For Models: 135 UK MODEL W/ 87MM ENGINE, TE20 W/ 85MM ENGINE SN 200001>, FE35 W/ 87MM ENGINE

A-1884897M1 Hose, Air Cleaner 0.25 Lbs.
Replaces: 826963M1

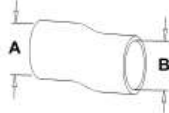

Dim/Info:
A- 2.07"
B- 1.80"

For Models: 35, 35X, T035

A-890258M1 Hose, Air Cleaner 0.50 Lbs.
Air cleaner to manifold

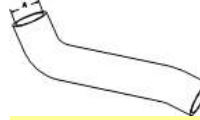

For Models: 35 W/ A3.152 PERKINS ENGINE

A-1861746M1 Hose, Air Cleaner 0.63 Lbs.
Replaces: 1672725M1

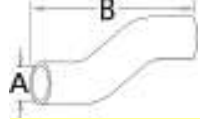

Dim/Info:
A- 1.94"
B- 9.00"

For Models: 148, 20B, 20D, 20E, 20F, 230, 240, 240S, 250, 30E, 135 UK MODEL

A-3637289M1 Pump, Fuel Lift Transfer 1.92 Lbs.



Dim/Info:
Pump Has 2 Mounting Holes

For Models: 850 SN <1746019115 W/ AV8.150 OR AV8.540, 760 SN 1746009413> W/ AV8.150 OR AV8.540, (1150, 1155 ALL W/ AV8.150 OR AV8.540)

A-4222110M91 Repair Kit, Fuel Pump 0.25 Lbs.
Replaces: 1882944M92



For Models: 260 SN <U552511G W/ AD4.203 ENGINE, (65, 765 ALL W/ A4.192 ENGINE), (155, 158, 165, 50, 560 UK, 65, 765 ALL W/ AD4.203 ENGINE), (1080, 285, 595 ALL W/ A4.318 ENGINE), (298, 698 ALL W/ A4.318.2 ENGINE), 595 MKII W/ A4.318.2 ENGINE, (1100, 500, 510, 515, 520, 525 ALL W/ A6.354 ENGINE), 1200 W/ A6.354.1 ENGINE, 1014 W/ A6.354.4 ENGINE

A-184208M2 Elbow, Exhaust 2.44 Lbs.



For Models: 65 W/ CONTINENTAL GAS ENGINE

A-1046679M1 Manifold 26.20 Lbs.
Replaces: 1750343M1, 1040903M1, BMD# B-175343M91







Dim/Info:
Includes Adapter and Gaskets,
But No Flange Bolts.

For Models: (TE20, TO20, TO30, TO35, 135, 35 ALL W/ CONTINENTAL GAS ENGINE)

- ALLIS CHALMERS
- CASE-IH
- CATERPILLAR
- CLARK
- DEUTZ
- FIAT
- FORD / NEW HOLLAND
- GEHL
- HYSTER
- IMT
- INGERSOLL RAND
- JACOBSEN
- JCB
- JOHN DEERE
- LANDINI
- LEYLAND
- LINCOLN ELECTRIC
- MASSEY FERGUSON
- MELROE
- MICHIGAN
- OWATTONA
- PERKINS USA
- RENAULT
- SULAIR CORP
- VERMEER
- WHITE/ OLIVER
- ZETOR

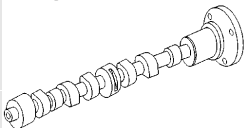
Engine Related Parts

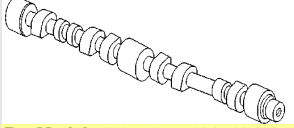
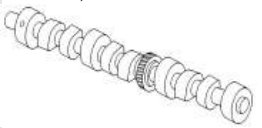
ALLIS CHALMERS	A-3609201M1 Sleeve, Exhaust Used w/ A-740695M1 exhaust outlet adapter	0.60 Lbs.
CASE-IH		
CATERPILLAR	For Models: 1105, 1135	
CLARK	A-825003M1 Gasket, Exhaust Elbow	0.02 Lbs.
DEUTZ	For Models: 135 UK MODEL W/ 87MM ENGINE, TEF20 W/ 20C ENGINE, FE35 W/ 23C OR 87MM ENGINE, TEA20 W/ 80MM OR 85MM ENGINE, TED20 W/ 85MM ENGINE	
FIAT	A-735057M1 Gasket, Head Cover	0.08 Lbs.
FORD / NEW HOLLAND		
GEHL	For Models: (135, 148, 20B, 20D, 20E, 20F, 230, 240, 250, 253, 254, 255, 30E, 30H, 350, 353, 355, 360, 363, 40, 40E, 550 ALL W/ AD3.152 OR AT3.152 PERKINS DIESEL ENGINES)	
HYSTER	A-745462M1 Gasket, Head Cover	0.10 Lbs.
IMT		
INGERSOLL RAND	For Models: 2640, 2675, 2705, 3505, 3525, 3545, 550, 699, 750, 850, 860, 855 SN 1696027544>, 760 SN 1746009413>, 865 SN 1746019115>, 399 W/ A6354.4 ENGINE	
JACOBSEN	A-733507M1 Camshaft Replaces: 31415261	9.24 Lbs.
JCB		
JOHN DEERE	For Models: (135, 150, 154-4, 154-4S, 20, 20C, 20D, 20F, 200 SERIES, 203, 205, 2135, 2200, 2244, 230, 231, 235, 240, 245, 250, 2500, 254-4, 30B, 30D, 30E, 30H, 350, 40, 4500, 4830FC, 5830, 5830FC, 5860, 5870 ALL FOR 152.7 IN. / 135 CU IN ENG)	
LANDINI	A-3637537M1 Camshaft	9.22 Lbs.
LEYLAND		
LINCOLN ELECTRIC		
MASSEY FERGUSON	For Models: (174-4S, 365, 375 ALL SN U0833N> W/ A4.236 PERKINS ENGINE), (3050, 362, 675 ALL SN U106655N> W/ A4.236 PERKINS ENGINE), (373, 377, 383, 387 ALL W/ A4.236 PERKINS ENGINE)	
MELROE	A-736818M1 Camshaft Replaces: 31415321, 31415374	9.22 Lbs.
MICHIGAN		
OWATTONA		
PERKINS USA	For Models: (165, 175, 180, 184-4, 255, 265, 270, 274-4, 275, 282, 283, 285, 290, 294-4, 30, 3050, 3060, 31, 375, 50C, 50D, 50E, 50H, 6500, 670, 690, 7500 ALL FOR 236 CU IN 248 CU IN 203 CU IN 203.5 CU IN), (11, 24, 300, 60 ALL FOR 236.248, 318, 203, 203.5 CU IN)	
RENAULT	A-836543M1 Camshaft For Z120, Z129 or Z134 Continental Engines	5.00 Lbs.
SULAIR CORP		
VERMEER		
WHITE/ OLIVER	For Models: TE20, TO20, 135, 202, 204, 2135, 2200, 30, 35, 50	
ZETOR		

A-1027656M1 Camshaft
For Continental Z145 Engine 5.00 Lbs.

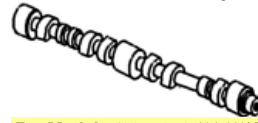

For Models: (135, 150 ALL W/ Z145 CONTINENTAL ENGINE)

A-3637539M1 Camshaft
Replaces: 31415264 8.50 Lbs.

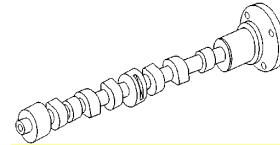

For Models: (253, 263 ALL AT3.152 Engine), 360, 364S SN <D03066 / T3.152.4 Engine, 40E T3.152.4 Engine

A-31134132 Bearing, Camshaft
Replaces: 31134132 0.22 Lbs.

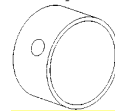

For Models: 910 ENG USED W/PERKINS DLS MOTOR, (11, 165, 174-4, 175, 175S, 180, 184-4, 220, 24, 25, 255, 265, 270, 275, 282, 283, 285, 290, 294-4, 30, 300, 3050, 3060, 3070, 31, 3120, 362, 50, 50C, 50D, 50E, 50H, 60, 60H, 6500, 6500H, 6530, 670, 6800H, 6830, 6830FC, 6860, 6870, 6880, 690, 7500, 7830, 7830C, 7860, 8500, 8530F, 8830, 8870, 888 ALL USED W/PERKINS DLS MOTOR)

A-736254M1 Gear, Camshaft (used w/ Perkins Diesel Engine) 3.78 Lbs.
Replaces: 31171353

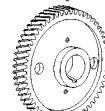

Dim/Info:
56 Teeth

For Models: 11, 1100, 1130, 1745, 180, 184-4, 220, 255, 2640, 2675, 270, 2705, 274-4, 282, 283, 285, 294-4, 30, 300, 3050, 3060, 3070, 3505, 3525, 3545, 3630, 399, 470, 50C, 50D, 50E, 50H, 60, 6500, 670, 699, 80, 850, 860, (165, 168, 175, 178, 185, 188, 265, 275, 290, 565, 575, 590, 690 ALL W/ENG A.212 / A4.236 OR A4.248)

A-731205M2 Gear, Idler, Camshaft
Replaces: 31164362 6.08 Lbs.



Dim/Info:
90 Teeth

For Models: 135, 148, 150, 154-4, 154-4S, 20, 200 SERIES, 203, 205, 20C, 20D, 20F, 2135, 220, 2200, 2200 W/ E-SN ENDING IN D, 2244, 230, 231, 235, 240, 245, 250, 2500 W/ E-SN ENDING IN D, 253, 254-4, 30B, 30E, 30H, 35, 35 UTILITY, 40, 40E, 4500, 4830FC, 50, 5830, 5830FC, 5860, 5870, 6030FC

A-731204M1 Hub, Idler Gear
Replaces: 995447 1.50 Lbs.



For Models: 135, 135 UK, 150, 154-4, 154-4S, 20, 203, 205, 20C, 20D, 20F, 2135, 2200, 2200, 230, 235, 240, 240P, 240S, 245, 250, 2500, 254-4, 263, 30B, 30D, 30E, 35, 35 UTILITY, 35X, 360, 364S, 40, 4500, 50 MASSEY HARRIS

A-1750237M1 Gear, Timing, Camshaft 3.00 Lbs.



For Models: (TE20, TO20, 135, 150, 30, 35, 50 ALL W/ CONTINENTAL GAS ENGINE)

Parts are not original equipment parts and are not sponsored, affiliated, or otherwise connected with any major brand.

Parts are not original equipment parts and are not sponsored, affiliated, or otherwise connected with any major brand.

A-731203M1 Gear, Timing, Camshaft 2.17 Lbs.
Replaces: 410241



Dim/Info:
50 Teeth

For Models: 150, 154-4, 154-4S, 20D, 20F, 200 SERIES, 203, 205, 231, 235, 240P, 245, 253, 254-4, 30E, 30H, 40E, 4830FC, 50, 5830, 5830FC, 5860, 5870, 6030FC, (TE20, 135, 148, 230, 240, 250, 35, 550 ALL ALL W/ENG TYPE PE 144 A3.152 / AD3.152), 2135 TURF

A-734738M91 Gear, Idler 5.00 Lbs.
Replaces: 41115023

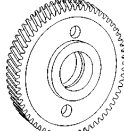

Dim/Info:
63 Teeth

For Models: 11, 168, 1745, 178, 185, 188, 220, 300, 565, 575, 590, 6830, 6830C, 6830FC, 6860, 6870, 6880, 7830, 7830C, 7860, 7880, 8530F, 8830, 8860, 8870, 8880, (675, 690 ALL ALL EARLY MODELS ALL W/ENG TYPE A4.212 A 4.248), 910 ENG

A-4224172M1 Housing, Rear Main 0.79 Lbs.
 For rope type seal.



For Models: (35, 65, 135, 148, 254, 765 ALL W/ PERKINS ENGINE)

A-31315148 Crankshaft, Keyed Nose, Rope Seal 47.30 Lbs.
Replaces: 3638473M91

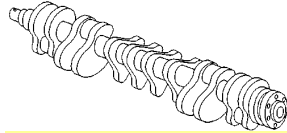

For Models: (ENGINE: D4.203, 4.203), 356, 65, (365, 65 ALL E-SN <2939035 NOT ENDING W/ DL), (165, 255, 30, 300, 302, 304, 3165, 40B, 50, 356, 65 ALL E-SN 29C1085>), (304, 165, 255, 300, 302, 3165, 356, 65 ALL E-SN 2939036-29C1084), (165, 255, 300, 50, 50, 65 ALL W/ A4.192, A4.203 OR AD4.203 SN <203UA109487DL)

A-3637458M91 Crankshaft, Keyed Nose, Lip Seal 66.90 Lbs.

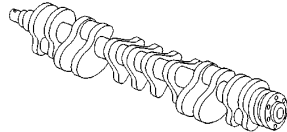

For Models: (ENGINE: D4.203, 4.203), (65, 165, 255, 302, 304, 3165, 356, 300 ALL E-SN 29C1085>)

A-ZZ90100 Kit, Crankshaft w/ Rope Seal 60.00 Lbs.

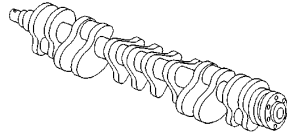

For Models: 30, 165 South Africa, 165 UK

A-ZZ90077 Kit, Crankshaft w/ Lip Seal 63.10 Lbs.

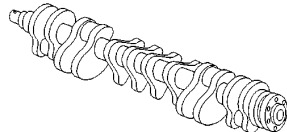

For Models: 30, 165 South Africa, 165 UK

Engine Related Parts

A-3637401M91 Crankshaft 72.00 Lbs.
Replaces: 3641825M91

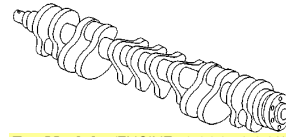

Dim/Info:
Splined Nose- 3 Bolt, Lip Seal

For Models: (ENGINE: 4.236, 4.248), (175, 255, 275, 50C ALL E-SN UA103064L-U106654N), 50C E-SN UA103064-U106654N

A-31315884 Crankshaft, Splined Nose, Rope Seal 68.70 Lbs.
Replaces: 738226M91, 3637789M91

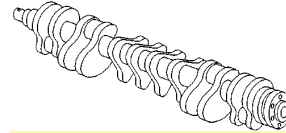

Dim/Info:
3 Bolt, Splined Nose, Rope Seal

For Models: (ENGINE: 4.236, 4.248), 275 E-SN <248UA123423L, (165, 255, 275 ALL E-SN <UA103063L), (50C, 6000 ALL E-SN <UA1030631)

A-3637408M91 Crankshaft, Keyed Nose, Lip Seal 102.00 Lbs.

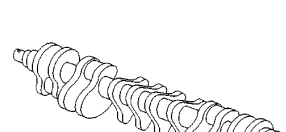

For Models: (1014, 3090, 699, 550 ALL 6.354.4 DSL), (1105, 1130, 1135, 750, 760 ALL T6.354.1/TC6.354.1 DSL), TX550 6.354.4 DSL, 6.354-4 ENGINE, 3 HOLES FOR PULLEY FITTING

A-3638303M1 Crankshaft, Splined Nose, Rope Seal 94.65 Lbs.
 This crankshaft uses a rope seal & has 12 mounting bolts to the flywheel.

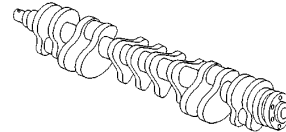

Dim/Info:
Eng SN <U327088L
Eng SN <U12128L, Rope Seal

For Models: 6.354-2

A-3637424M91 Crankshaft, Splined Nose, Lip Seal 101.90 Lbs.

This crankshaft uses a lip seal & has 6 mounting bolts.

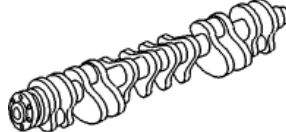

Dim/Info:
Eng SN U327089L>
Eng SN U12128L>, Lip Seal

For Models: 1100 E-SN <354UA10361, 6.354-2

A-734628M1 Pulley, Crankshaft 7.00 Lbs.
 Uses A-704812M93 hydraulic adapter plate







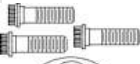

Replaces: 31147784

For Models: (135, 150, 20 ALL Gas Eng. SN <152UA22587A / All Diesel), (203, 205 ALL Diesel), 20D, 20F, 2135 Utility, 2200, 230, (235, 245 ALL Orchard), 2500, 30B Diesel, 30D, 30E, 30H, 35 Diesel, 40 Gas Eng. SN <152UA22587A / All Diesel, 40E, 4500, 50 Diesel, 65 Eng. SN <2820092, (FE35, MF20C ALL Diesel), T035 Equipped W/ 102 Loader

- ALLIS CHALMERS
- CASE-IH
- CATERPILLAR
- CLARK
- DEUTZ
- FIAT
- FORD / NEW HOLLAND
- GEHL
- HYSTER
- IMT
- INGERSOLL RAND
- JACOBSEN
- JCB
- JOHN DEERE
- LANDINI
- LEYLAND
- LINCOLN ELECTRIC
- MASSEY FERGUSON
- MELROE
- MICHIGAN
- OWATTONA
- PERKINS USA
- RENAULT
- SULAIR CORP
- VERMEER
- WHITE/ OLIVER
- ZETOR

Engine Related Parts

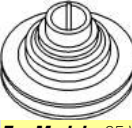
ALLIS CHALMERS	A-VPC4105	Pulley Kit, Crankshaft	0.83 Lbs.
	For 1004.4, 1004.4T, 1004.4TI, 4.41, A4.236 & A4.248 Perkins Engines w/ 3 bolt crankshaft.		
CASE-IH			
CATERPILLAR			
CLARK	For Models: (168, 175 ALL SN 236UA103064L>, Lip Type Seal), (178, 185, 188 ALL SN 248UA123424L>, Lip Type Seal), (265, 274, 275, 285, 3050 ALL Lip Type Seal), 3075, (362, 365, 372, 373, 375, 377, 383, 387, 393, 397 ALL Lip Type Seal), (4225, 4235, 4240, 4245, 4255 ALL Engine Build Number Prefix LM), (50, 50B, 50EX, 50H, 50HX, 50HX SERIES S, 565, 575, 60H, 60H SERIES S ALL Lip Type Seal), 6110, 6120, 6130, 6140, 6150, 675 Lip Type Seal		
DEUTZ			
FIAT			
FORD / NEW HOLLAND	A-VPC5122	Seal Kit, Crankshaft, Front & Rear	0.70 Lbs.
	Kit contains front & rear crank seals, felt seal & gasket for rear seal retainer.		
GEHL			
HYSTER	For Models: (Z120, Z129, Z134, Z145 ALL CONTINENTAL GAS ENGINE)		
	A-31171211	Gear, Crankshaft (6.354)	1.21 Lbs.
	Replaces: 733757M1, 159162A		
IMT			
INGERSOLL RAND			
JACOBSEN	For Models: 1100, 1105, 1130, 1135, 2640, 2675, 2705, 3505, 3545, 510, 550, 5650 BRAZIL, 699, 750, 760, 80, 850, 860		
JCB	A-1750284M1	Gear, Crankshaft Timing	1.10 Lbs.
		Dim/Info: 24 Teeth	
JOHN DEERE			
LANDINI	For Models: (TE20, TO20, 30 ALL W/ CONTINENTAL GAS ENGINES)		
	A-1750054M1	Gear, Crankshaft Timing	1.00 Lbs.
LEYLAND		Dim/Info: 24 Teeth	
LINCOLN ELECTRIC	For Models: (TO35, 135, 150, 35, 50 ALL W/ CONTINENTAL GAS ENGINE)		
MASSEY FERGUSON	A-734627M1	Pulley, Crankshaft	6.15 Lbs.
	Replaces: Perkins # 31143733		
MELROE			
MICHIGAN	For Models: 360, 20 TURF TRACTOR GAS SN <152UA25587A, ALL TURF DIESELS, 2135 TURF TRACTOR W/ DIESEL ENGINE, 240 W/ AD3.152 DIESEL ENGINE, 235 W/ DIESEL ENGINE, 35 W/ PERKINS DIESEL ENGINE SN 1861319>, 135 W/ PERKINS GAS ENGINE SN <152UA25587A, ALL DIESEL ENGINE		
OWATTONA			
PERKINS USA	A-734563M1	Pulley, Crankshaft	8.12 Lbs.
		Dim/Info: (3) 3/8"- 16 Tapped Holes	
RENAULT			
SULAIR CORP	For Models: 65 W/ REGULAR AND DIRECT INJECTION DIESEL ENGINES		
VERMEER			
WHITE/ OLIVER			
ZETOR			

A-3638318M1 Pulley, Crankshaft 6.21 Lbs.
Replaces: 31148791, 31148792, 31148797, 31148798, 31154612, 3637520M1, 734506M1, 734812M1, 735506M1



For Models: 180, 184-4, 255, 265, 274-4, 275, 282, 294-4, 50C, 60 LATE PRODUCTION, 165 SOUTH AFRICA ONLY, 175 W/ DIESEL ENGINE

A-746432M91 Balancer Assembly w/ Oil Pump 43.10 Lbs.
Replaces: 41733082

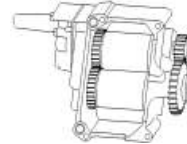

For Models: 11, 1745, 175, 180, 184-4, 220, 24, 255, 265, 270, 274-4, 275, 282, 283, 285, 290, 3070, 31, 50, 50C, 50D, 50E, 50H, 60, 60HT, 6500, 6500H, 670, 6800H, 6830, 6830C, 690, 7830, 8830

A-BRK1618 Repair Kit, Balancer 5.69 Lbs.
Kit contains: (2) A-746697M1 (2) A-746696M1 (1) A-743137M1 (1) A-743115M1 (1) A-743020M1 (1) A-734850M1 (1) 734849M1 & (2) A-376588X1

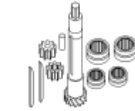

For Models: (50, 50B, 168, 175 ALL W/ A4.236 PERKINS ENGINE), (174-4S, 265, 274, 275 ALL SN <880190K W/ A4.236 PERKINS ENGINE), (285, 290 ALL SN <880190K W/ A4.236 PERKINS ENGINE), (30D, 50D, 565, 575 ALL SN <880190K W/ A4.236 PERKINS ENGINE), 590 SN <880190K W/ A4.248 PERKINS ENGINE, 675 SN <880190K W/ A4.236 PERKINS ENGINE, 690 SN <880190K W/ A4.248 PERKINS ENGINE, (178, 185, 188 ALL W/ A4.248 PERKINS ENGINE), 60H W/ BUILD #S LF31128, 31135, 31180 W/ A4.248 PERKINS ENGINE

A-743137M1 Shaft, Balancer Drive 2.50 Lbs.
Replaces: 32731127

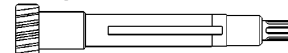

For Models: 11, 165, 168 W/ A4.236 Eng., 174-4S W/ A4.236 Eng. SN<880190K, 175, 178 W/ A4.248 Eng. SN<880190K, 180, 184-4, (185, 188 ALL W/ A4.248 Eng. SN<880190K), 220, 24, 25, 255, 265 W/ A4.236 Eng. SN<880190K, 270, 274 W/ A4.236 Eng. SN<880190K, 274-4, 275 W/ A4.236 Eng. SN<880190K, 282, 283, (285, 290 ALL W/ A4.248 Eng. SN<880190K), 294-4, 30, (30D, 50, 50B, 50B MKII ALL W/ A4.236 Eng. SN<880190K), 50C, (50D, 50E, 50EX ALL W/ A4.236 Eng. SN<880190K), 50EX W/ A4.248 Eng. SN<880190K, 50H W/ A4.

A-743115M1 Shaft, Balancer Drive 1.91 Lbs.
Replaces: 32731127

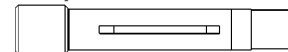

For Models: 11, 165, 168, 1745, 175, 178, 180, 184-4, 185, 188, 220, 24, 255, 270, 274-4, 282, 283, 285, 290, 294-4, 30, 50, 50C, 50D, 50E, 50H, 565, 575, 590, 60, 60HT, 6500, 6500H, 670, 6800H, 6830, 7830, 8830C, (265, 275, 675, 690 ALL EARLY MODELS W/ ENG TYPE A4.212 / A4.236 / A4.248)

A-734850M1 Gear, Balancer (not splined) 0.19 Lbs.
Replaces: 31165461

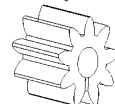

For Models: 11, 165, 168, 1745, 175, 178, 180, 184-4, 185, 188, 220, 24, 25, 255, 265, 270, 274-4, 275, 2805, 282, 283, 285, 290, 294-4, 30, 31, 50, 50C, 50D, 50E, 50H, 565, 575, 590, 60, 60H, 60HT, 6500, 6500H, 670, 675, 6800H, 6830, 6830C, 690, 7830, 7830C, 8830

Parts are not original equipment parts and are not sponsored, affiliated, or otherwise connected with any major brand.

Parts are not original equipment parts and are not sponsored, affiliated, or otherwise connected with any major brand.

Engine Related Parts

A-743020M1 Gear, Balancer (splined) 0.16 Lbs.
Replaces: 31165531

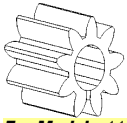

For Models: 11, 165, 168, 1745, 175, 178, 180, 184-4, 185, 188, 220, 24, 25, 255, 270, 274-4, 275, 282, 283, 285, 290, 294-4, 30, 31, 50, 50C, 50D, 50E, 565, 575, 590, 60, 60H, 60HT, 6500, 6500H, 670, 6800H, 6830, 6830C, 7830, 7830C, 8830, (265, 675, 690 ALL EARLY MODELS / ALL WITH ENG TYPE A4.212 / A4.236 / A4.248)

A-746694M1 Gear, Balancer 1.00 Lbs.



For Models: 265, 274-4, 275, 282

A-3637329M1 Gear, Balancer 6.36 Lbs.
Replaces: 3116K004

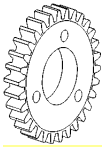

Dim/Info:
38 Teeth

For Models: 174-4, 265S Turkey, 270, 271, 274-4 S/N 221N00936>, 275 UK, 281, 283, 283 UK, 290, 290 UK, 294-4, 362, 365 S/N B18009>, 374S S/N <D03066, 375, 383, 384S S/N <D03066, 390, 390T, 393, 394S S/N <D03066, 398, 690, 1745, 3050, 3060, 3065, 3070, 3075, 4225, 4235, 4240, 4243, 4245, 4253, 4255, 4265, 4325, 4335, 4345, 4355, 6140, 6150, 6235, 6245, 6255, 6265, 6560, 6830, 6830FC, 6870, 6880, 7830, 7860, 7870, 7880, 8530F, 8830, 8860, 8870, 8880, 50E, 50F, 50H, 885

A-746693M1 Weight, Balancer 0.80 Lbs.

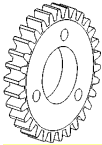

For Models: 11, 1745, 175, 180, 184-4, 220, 24, 25, 255, 265, 270, 274-4, 275, 282, 283, 285, 290, 31, 50, 50C, 50D, 50E, 50H, 60, 60H, 60HT, 6500, 6500H, 670, 6800H, 6830, 6830C, 690, 7830, 7830C, 8830

A-1750274M1 Gasket, Timing Cover 0.30 Lbs.



Dim/Info:
5

For Models: T020, T030

A-734661M1 Gasket, Front Cover to Timing Gear Housing 0.26 Lbs.
Replaces: 36813136



For Models: 135, 150, 154-4, 154-4S, 20, 20C, 20D, 20F, 203, 205, 2135, 2200, 2244, 230, 231, 235, 240, 245, 250, 2500, 253, 254-4, 30B, 30D, 30E, 30H, 35, 350, 360, 40, 40E, 4500, 4830FC, 50, 5830, 5830FC, 5860, 5870, 6030FC, 6070

A-734887M1 Gasket, Front Cover to Timing Gear Housing 0.09 Lbs.
Replaces: 36813137



Dim/Info:
2

For Models: 11, 165, 1745, 175, 180, 184-4, 220, 24, 25, 255, 265, 270, 274-4, 275, 282, 283, 285, 290, 294-4, 300, 3050, 3060, 3070, 31, 362, 375, 383, 390, 390T, 393, 398, 399, 470, 50, 50C, 50D, 50E, 50H, 60, 60H, 60HT, 6500, 6500H, 670, 6800H, 6830, 6830C, 6830FC, 6860, 6870, 6880, 690, 7830, 7830C, 7860, 7870, 8530F, 8830, 8860, 8870, 8880

A-742474M1 Gasket, Timing Cover 0.10 Lbs.
Replaces: 36814127, 36814123

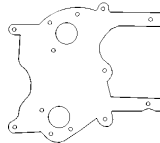

Dim/Info:
2

For Models: 11, 165, 1745, 175, 180, 184-4, 220, 255, 265, 270, 274-4, 275, 282, 283, 285, 290, 294-4, 30, 300, 3050, 3060, 3070, 31, 375, 383, 390, 50C, 50D, 50E, 50H, 60, 6500, 670, 6830, 6830C, 6830FC, 690, 7830, 8530F

A-732687M1 Gasket, Timing Cover 0.15 Lbs.
Replaces: 36814116

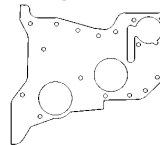

For Models: 165, 255, 30, 300, 302, 304, 3165, 356, 40B, 50, 50A, 65

A-735848M1 Gasket, Timing Cover 0.06 Lbs.
Replaces: 36813144

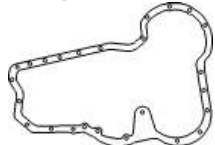

Dim/Info:
5

For Models: 1100, 1130, 165, 255, 30, 300, 302, 304, 3165, 356, 40B, 50, 50A, 65

A-734238M1 Gasket, Timing Cover 0.08 Lbs.
Replaces: 36814119

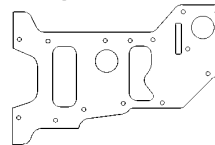

Dim/Info:
2

For Models: 135, 150, 154-4, 154-4S, 20, 20C, 20D, 20F, 200 SERIES, 203, 205, 2135, 2200, 2244, 230, 231, 235, 240, 2400, 245, 250, 2500, 253, 254-4, 30B, 30D, 30E, 30H, 35, 350, 360, 40, 40E, 4830FC, 50, 5500, 5830, 5830FC, 5860, 5870, 6030FC, 6070, 6830C, 7830, 7830C, 8830

A-1750024M1 Gasket, Pan 0.05 Lbs.

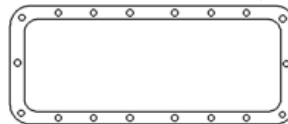

For Models: F40, TE20, T020, T030, T035, 135, 150, 202, 204, 2135, 2500, 35, 50



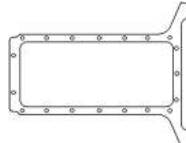



A-1753804M1 Gasket, Pan 0.39 Lbs.

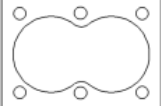

For Models: 3165, 65

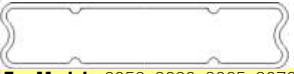
- ALLIS CHALMERS
- CASE-IH
- CATERPILLAR
- CLARK
- DEUTZ
- FIAT
- FORD / NEW HOLLAND
- GEHL
- HYSTER
- IMT
- INGERSOLL RAND
- JACOBSEN
- JCB
- JOHN DEERE
- LANDINI
- LEYLAND
- LINCOLN ELECTRIC
- MASSEY FERGUSON
- MELROE
- MICHIGAN
- OWATTONA
- PERKINS USA
- RENAULT
- SULAIR CORP
- VERMEER
- WHITE/ OLIVER
- ZETOR

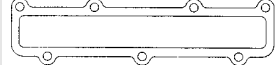
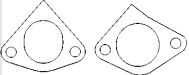
Engine Related Parts

ALLIS CHALMERS	A-1750087M1	Gasket, Oil Pump Body Cover	0.02 Lbs.
CASE-IH		Dim/Info: 5	
CATERPILLAR	For Models: F40, T035, 35, 50		
	A-1750006M1	Gasket, Vent Cover	0.02 Lbs.
CLARK			
DEUTZ	For Models: T020, T030, 135, 150, 35, 50		
FIAT	A-011277X	Washer, Head Cover	0.01 Lbs.
FORD / NEW HOLLAND		Dim/Info: 3/8" I.D. X 5/8" O.D.	
GEHL	For Models: TE20, T020, T030		
	A-3638482M1	Gasket, Head Cover	0.20 Lbs.
HYSTER			
IMT	For Models: 3050, 3060, 3065, 3070, 383, 393, 670, 690, (375, 390, 398 ALL S/N <B18008), 390T S/N <B18009, (374S, 374V, 384S, 394S ALL S/N <D03066), 265S Turkey, 25, 60, 6500, T4-236		
INGERSOLL RAND	A-180060M1	Gasket, Sediment Bowl (15 pack) Used w/ 2" Bowl	0.01 Lbs.
JACOBSEN		Dim/Info: 2" O.D.	
JCB	For Models: F40, T035, 202 SN <309328, 203 SN <119700213, 204 SN <343891, 304 SN <119750210, 35, 35 INDUSTRIAL MODEL, 356 SN <670001084, 50, 65, 85, 88		
JOHN DEERE	A-1750045M1	Gasket, Manifold	0.14 Lbs.
LANDINI	For Models: (135, 35, TE20, T020, T030, T035 ALL W/ CONTINENTAL GAS ENGINE)		
LEYLAND	A-738703M1	Gasket, Inlet Manifold	0.04 Lbs.
LINCOLN ELECTRIC	Replaces: 36867131		
MASSEY FERGUSON			
	For Models: 135, 150, 154-4, 20, 20C, 20D, 20F, 200 SERIES, 203, 205, 2135, 2200, 2244, 230, 231, 235, 240, 240P, 245, 250, 2500, 254-4, 30B, 30D, 30E, 30H, 350, 40, 4500, 4830FC, 5830, 5830FC, 5860, 5870		
MELROE	A-36862133	Gasket, Inlet Manifold	0.07 Lbs.
MICHIGAN			
OWATTONA	For Models: 165 UK, 174-4S, 175 UK, 178 UK, 270, 282, 283, 290, 294-4 S/N 223000321>, 362, (374S, 374V ALL S/N <D03066), 375, 383, 390, 1745, 6830FC, 7830FC, 7870, 7880, 8860, 8870, 8880, 11, 24, 25, 31, 50C, 50D, 50E, 50F, 50H, 50H SERIES S, 50HX, 50HX SERIES S, 60, 60H, 60H SERIES S, 220, 300, 5800H, 6500, 6500H, 6800H		
PERKINS USA			
RENAULT	A-736754M1	Gasket, Exhaust Manifold	0.02 Lbs.
SULAIR CORP	Replaces: 36862134		
		Dim/Info: 5	
VERMEER	For Models: 11, 165, 1745, 175, 180, 184-4, 194, 24, 25, 255, 265, 270, 274-4, 275, 282, 283, 285, 290, 294-4, 30, 300, 3050, 3060, 31, 362, 375, 383, 390, 50C, 50D, 50E, 50H, 60, 60H, 6500, 6500H, 670, 6800H, 6830, 6830C, 6830FC, 6860, 6870, 6880, 690, 7830, 7830C, 7860, 7870, 7880, 8530F, 8830, 8860, 8870, 8880		
WHITE/OLIVER			
ZETOR			

A-181531M1 Gasket, Carburetor Mounting 0.01 Lbs.



Dim/Info:
10

For Models: (TE20, T020, T030, T035, 135, 35 ALL W/ CONTINENTAL GAS ENGINE)

A-41314113 Pump, Oil 5.95 Lbs.
Replaces: 737964M92



For Models: 285, 595, 1080, 1085, 540

A-41314164 Pump, Oil 5.00 Lbs.
Replaces: 1447483M1, 736617M91, 41314164, 3638633M91



For Models: 356 E-SN <2820092, 365 E-SN <2939035 NOT ENDING W/ DL, (30, 302, 3165, 40B, 50 ALL E-SN 29C1085>), 304 E-SN 2939036-29C1084, (165, 235, 255, 50, 65 ALL W/ A4.203 OR AD4.203 PERKINS DIESEL ENGINE)

A-4132F015 Pump, Oil 7.35 Lbs.



For Models: 1014, 2675, 3090 E-SN <U737602M, 3090 E-SN U737603>, 3650, 699 E-SN <U737602M, 699 E-SN U737603>, 550, 560 UK, 660 UK, 750, 850, TX550

A-739400M91 Pump, Oil 8.15 Lbs.

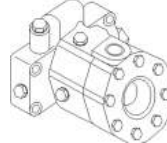

Dim/Info:

Check w/ Build List
Pump is 8.5" Long w/ 4" Shaft Length

For Models: 1100 E-SN <354UA10361

A-747293M91 Pump, Oil 8.94 Lbs.



For Models: (TRACTOR: 2705, 3525, 3545, 3630, 3650), (COMBINE: 750, 760 S/N 1746009413->, (850, 855 ALL S/N 1696027544->), 860, 865)

A-41314067 Pump, Oil 9.61 Lbs.
Replaces: 736012M91



Dim/Info:

Check w/ build list
Pump is 11.5" Long, w/ 8" Shaft Length

For Models: 1100 E-SN <354UA10361, 1100 E-SN 354UA10362>, 1105, 1130 E-SN <354UA3355T, 1130 E-SN 354UA3355T>, 1135, (COMBINE: 750, 760 E-SN UA48970I->)

A-736012M1 Pump, Oil 5.10 Lbs.



For Models: (1100, 1105, 1130, 1135, 740, 750, 760 ALL W/ A6.354 PERKINS DIESEL ENGINE)

Parts are not original equipment parts and are not sponsored, affiliated, or otherwise connected with any major brand.

Engine Related Parts

Parts are not original equipment parts and are not sponsored, affiliated, or otherwise connected with any major brand.

A-4132F012 Pump, Oil 4.60 Lbs.



For Models: (698, 3065, 3370 ALL E-SN U106655N>)

A-3638595M91 Pump, Oil 6.52 Lbs.



For Models: 3085, 3095, 3115, 399, (4260, 4270 ALL Build # prefix YA), 6160, 6170 USA S/N < F014037

A-3641171M91 Pump, Oil 6.79 Lbs.



For Models: 3140, 4260, 4263, 4270, 4360, 6170, 6180, 6270, 6280, 6290, 8120, 8210, 8220, (3120T, 3125, 3645, 3655, 3660, 6190 ALL T6.60 Engine)

A-3637489M91 Pump, Oil 5.89 Lbs.



For Models: 1007, 3050, 3060, 3065, 3070, 3075, 362, 365, 373, 375, 377, 382, 383, 387, 390, 390T, 393, 397, 398, 4225, 4235, 4240, 4245, 4255, 4325, 4335, 4345, 6110, 6120, 6130, 6140, 6150, 6235, 6245, 6255, 6265, 698T, (174-4S, 265, 274, 275, 285, 290, 30D, 565, 575, 590, 675, 690 ALL S/N 880191K>), 50E Build nos. LD31114 & L31199

A-827501M91 Rotor Assembly, Oil Pump 0.56 Lbs.
Replaces: 1884112M91

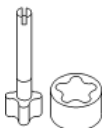

For Models: FE35, TEA20, TED20, 135 UK

A-826059M91 Kit, Engine Oil Pump (23C) 0.51 Lbs.
Replaces: 827615M91



For Models: 35X, FE35, TEF20, T035

A-731628M91 Gear, Timing Idler, Lower 4.23 Lbs.
Replaces: 731797M91, Perkins# 41115004



For Models: (155, 158, 165, 260, 50, 560 ALL W/ AD4.203 Engine), (65, 765 ALL W/ A4.192 & AD4.203 Engine)

A-747454M1 Cover, Timing 3.40 Lbs.
Replaces: 737211M91, 740226M1



For Models: (135, 230, 240, 250, 35, 350, 355, 360, 550 ALL W/ A3.152 OR AD3.152 PERKINS DIESEL ENGINES)

A-1753826M1 Gasket, Timing Cover 0.30 Lbs.

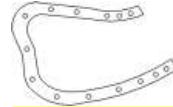

For Models: 65

A-1750032M1 Gasket, Timing Cover 0.06 Lbs.



Dim/Info:
5

For Models: T035, 35, 50

A-826094M1 Chain, Timing 1.00 Lbs.



For Models: FE35, T035, 35X

A-1750112M1 Gasket, Rear Engine Oil Seal Retainer 0.02 Lbs.



Dim/Info:
Use w/ A-1750216M91 Seal
5

For Models: F40, TE20, T020, T030, T035, 135, 150, 165, 175, 180, 202, 204, 20C, 2135, 2200, 230, 235, 245, 2500, 302, 304, 30B, 3165, 35, 4500, 50, 65

A-376501X1 Drain Plug, Oil Pan 0.16 Lbs.

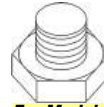

For Models: 1007, 1080, 1100, 1200, 1250, 135, 148, 165, 168, 174-4S SN <U923014K, 175, 178, 185, 188, 20D, 240, 250, 254, 255, (2620, 2640, 2645, 2680 ALL SN <S271212), 274, 285, 290, 3050, 3060, 3065, 3070, 3080, 3090, 3095, 3115, 3125, 35, 360, 362, 363, 3630, 3645, 365, 3650, 3655, 375, 390, 390T, 398, 399, 40, 50, 50B, 530, 535, 550, 560, 560 UK, 565, 565, 575, 590, 595, 620, 625, 660, 665, 675, 690, 698, 750

A-1750025M1 Gasket, Oil Pan Flange (2 Required) 0.01 Lbs.

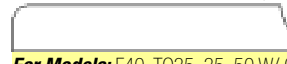

Dim/Info:
2

For Models: F40, T035, 35, 50 W/ GAS ENGINE

A-4222025M91 Sump, Oil 79.00 Lbs.



For Models: 240S TURKEY





A-3638306M1 Sump, Oil 71.00 Lbs.

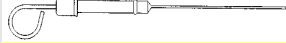

For Models: 290 UK, 3050, 3060, 3070, 362, 365, 375, 383, 390, 390T, 394S, 398

- ALLIS CHALMERS
- CASE-IH
- CATERPILLAR
- CLARK
- DEUTZ
- FIAT
- FORD / NEW HOLLAND
- GEHL
- HYSTER
- IMT
- INGERSOLL RAND
- JACOBSEN
- JCB
- JOHN DEERE
- LANDINI
- LEYLAND
- LINCOLN ELECTRIC
- MASSEY FERGUSON
- MELROE
- MICHIGAN
- OWATTONA
- PERKINS USA
- RENAULT
- SULAIR CORP
- VERMEER
- WHITE/ OLIVER
- ZETOR

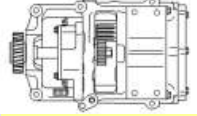
Engine Related Parts

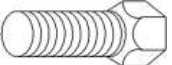
ALLIS CHALMERS	A-734962M91 Cap, Oil Filler <i>Replaces:</i> Perkins# 2487854	0.09 Lbs.
CASE-IH		
CATERPILLAR	<i>For Models:</i> 135 UK, 154-4, 154-4S, 165 UK, 174-4S, 175 UK, 178 UK, 184-4, 194-4, 20D, 20E, 20F, 231, 24, 240, 240P, 25, 253, 254-4, 255 SN 230UA127650DL>, 265S, 270, 274-4, 275 UK, 282, 283, 283 UK, 285S, 290, 290 UK, 294-4, 3050, 3060, 3065, 3070, 3075, 30E, 30H, 360, 362, 3645, 364S, 365, 375, 383, 390, 390T, 393, 398, 40B, 40E, 50E Power Shuttle, 50F, 50H, 60, 60H, 6140, 6150, 6500H, 670, 6800H, 690	
CLARK		
DEUTZ		
FIAT	A-731117M91 Dipstick, Oil <i>Replaces:</i> 31786412	0.11 Lbs.
FORD / NEW HOLLAND		<i>Dim/Info:</i> 7" Length
GEHL	<i>For Models:</i> 35 ALL W/A3.152 / AD3.152 ENG, 50, (135, 148 ALL W/A3.152 / AD3.152 ENG), 150, 154-4, 154-4S, 230, 231, 235, 240 ALL W/A3.152 / AD3.152 ENG, 245, 250 ALL W/A3.152 / AD3.152 ENG, 253, 254-4, 255, 350, 360, (65, 765 ALL W/A4.192 / A4.203 / AD4.203 ENG), 20, 20C, 20D, 30, 30B, 30D, 40, 40B, 50A, 158 ALL W/A4.192 / A4.203 / AD4.203 ENG, 202, 203, 205, 302, 304, 356, 2135 TURF UTIL / NARROW, 3165, 4500, 4830FC, 300, 550 ALL W/A3.152 / AD3.152 ENG, 5830, 5830FC, 5860, 5870, 6030FC, 6070	
HYSTER		
IMT	A-735129M91 Dipstick, Oil <i>Replaces:</i> 31787437	0.07 Lbs.
INGERSOLL RAND		<i>Dim/Info:</i> 9" Length
JACOBSEN	<i>For Models:</i> 11, 1100, 1130, 130, 1745, 175, 184-4, 25, 270, 274-4, 294-4, 30, 31, 50, 50C, 50D, 50E, 60HT, 670, 6830, (165, 168, 265, 275, 285, 565, 575 ALL ALL W/ ENG TYPE A4.212 / A4.236 / A4.248)	
JCB	A-3637352M1 Balancer Assembly	67.71 Lbs.
JOHN DEERE		
LANDINI	<i>For Models:</i> (50E, 60H ALL LATE TYPE/ 6 BOLT FIXING AND 3637489M91 OIL PUMP), (30D, 50D ALL SN 880191K> LATE TYPE/ 6 BOLT FIXING AND 3637489M91 OIL PUMP), (174-4S, 265, 274, 275, 565, 575 ALL SN 880191K> W/ PERKINS A4.236 OR AT4.236 ENGINES), (285, 290, 590, 690 ALL SN 880191K> W/ PERKINS A4.248 ENGINE), (3060, 393, 397 ALL W/ A4.248 PERKINS ENGINE), 3070 W/ PERKINS A4.236 OR AT4.236 ENGINE, (1007, 3050, 3065, 373, 375, 377, 383, 387, 398 ALL W/ PERKINS A4.236 OR AT4.236 ENGINES)	
LEYLAND		
LINCOLN ELECTRIC		
MASSEY FERGUSON	A-746696M1 Bearing, Front Balancer Shaft <i>Replaces:</i> 2557181, 2557176	0.10 Lbs.
MELROE		
MICHIGAN	<i>For Models:</i> 168, 50C, (174-4S, 178, 185, 188, 265, 274, 275, 285, 290, 30D, 50, 50B, 50B MKII, 50D, 50E, 50EX, 50H, 50H SERIES S, 50HX, 50HX SERIES S, 565, 575, 590, 60H, 60H SERIES S, 675, 690 ALL S/N <880190K)	
OWATTONA		
PERKINS USA	A-0095250 Bolt, Connecting Rod For connecting for models w/ Perkins A3.152, AD3.152, AT3.152, A4.192 & AD4.203 Engines.	0.14 Lbs.
RENAULT		
SULAIR CORP	<i>For Models:</i> 135, 148, 154-4S, 158, 165, 20B, 20D, 20E, 20F, 230, 240, 250, 253, 254, 255, 260, 30E, 30H, 35, 350, 353, 355, 360, 363, 40 INDUSTRIAL, 40E, 50 INDUSTRIAL, 550, 65, 760, 765	
VERMEER		
WHITE/ OLIVER		
ZETOR		

A-3637389M1 Head, Cylinder
Includes valves, guides & springs assembled.
Replaces: 743201M1, ZZ080082

48.98 Lbs.

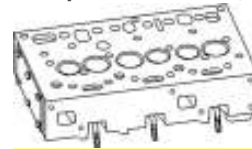

For Models: (135, 150, 20, 2135, 230, 235, 40 ALL W/ PERKINS AD3.152 DIESEL ENGINE)

A-3637486M1 Head, Cylinder
Includes valves, guides & springs assembled.
Replaces: 743112M1, ZZ080054

80.00 Lbs.

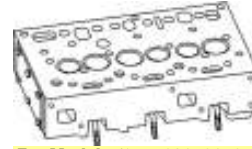

For Models: (175, 180, 20, 255, 265, 275, 31, 40 ALL W/ PERKINS A4.236 & A4.248 DIESEL ENGINES)

A-3637784M1 Head, Cylinder
Includes valves, guides & springs assembled.
Replaces: 743272M1, ZZ080058

46.00 Lbs.

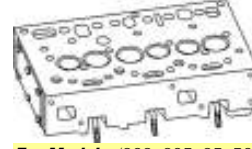

For Models: (203, 205, 35, 50 ALL W/ PERKINS A3.152 DIESEL ENGINE)

A-1750062M1 Seal, Intake Valve Oil Guard
Dim/Info:
4

0.01 Lbs.



For Models: TE20, T020, T035, 35

A-1446176M91 Heater Plug
Replaces: 1021910M91, Perkins# 2666805

0.17 Lbs.

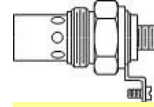

For Models: FE35 W/ 23C Engine

A-893501M1 Heater Plug, Thermostat Burner w/ Thread Connector
Replaces: 13H2468, 2666103

0.15 Lbs.

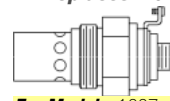

For Models: 1007, 1014, 1114, 1134, 1250, 135, 148, 165, 168, 174, 175, 178, 185, 188, 20B, 20D, 20E, 20F, 230, 240, 250, 255, 265, 275, 285, 290, 3050, 3060, 3065, 3070, 30D, 30E, 30H, 35, 350, 353, 355, 360, 363, 365, 373, 375, 377, 383, 387, 390, 390T, 393, 397, 398, 399, 40E, 50, 50B, 50D, 50E, 530, 535, 550, 560, 565, 565, 575, 590, 60H, 65, 660, 665, 675, 690, 698, 699, 800, 805, 820, 825, 830, 835, 840, 845

A-3583543M1 Heater Plug, Thermostat Burner
Replaces: 1446935M1

0.18 Lbs.

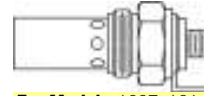

For Models: 1007, 1014, 1080, 1114, 1134, 1250, 135, 148, 165, 168, 175, 178, 185, 188, 20B, 20D, 20E, 20F, 230, 240, 250, 255, 265, 270, 275, 285, 290, 298, 3050, 3060, 3065, 3070, 30D, 30E, 30H, 350, 353, 355, 360, 363, 365, 373, 375, 377, 383, 387, 390, 390T, 393, 397, 398, 399, 40E, 50, 50B, 50D, 50E, 530, 535, 550, 5500, 560, 560 UK, 565, 565, 575, 590, 595, 60H, 660, 665, 670, 675, 690, 698, 699, 800, 805, 820, 825, 830, 835, 840, 845

Parts are not original equipment parts and are not sponsored, affiliated, or otherwise connected with any major brand.

Parts are not original equipment parts and are not sponsored, affiliated, or otherwise connected with any major brand.

A-3599307M1 Switch, Oil Pressure Sender 0.08 Lbs.



For Models: 154S, 184-4, 20D, 20F, 240, 250, 253, 2620, 2625, 2640, 2645, 265, 2675, 2680, 2685, 270, 2705, 2720, 2725, 274-4, 2745, 275, 2775, 2805, 283, 285, 290, 294-4, 298, 3050, 3060, 3065, 3070, 3080, 3085, 3090, 3095, 30E, 30H, 3115, 3120, 3125, 340, 350, 3505, 3525, 3545, 355, 360, 362, 3630, 3645, 365, 3650, 3655, 375, 383, 390, 393, 398, 399, 40E, 50E, 50H, 50HX, 550, 565, 575, 590, 592, 595, 60H, 60HX, 6500H, 670, 675, 6800H, 690, 698, 698T, 699

A-1693367M1 Switch, Hydraulic Pressure 0.20 Lbs.

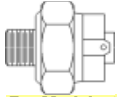

For Models: 360, 362, 365, 375, 383, 390, 390T, 393, 396, 398, 399, 40E, 4225, 4235, 4240, 4243, 4245, 4253, 4255, 4260, 4263, 4265, 4270, 4325, 4335, 4345, 4355, 4360, 4370, (30E, 50E ALL POWER SHUTTLE)

A-825157M91 Governor Cup & Shaft 0.37 Lbs.

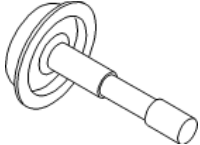

For Models: FE35, TEA20, TED20, 135 UK

A-773323M1 Heater, Engine Block Frost Plug w/ 3/4" NPT 400 Watt 0.83 Lbs.

Must be used w/ MF engine heater adapter 191184M1



Dim/Info:
3/4" NPT
400 Watt

For Models: SUPER 90, 135, 180, 235, 265, 275, 285, 35, 50, 65, 85, 88

A-47V1535 Cable, T Handle Pull (82") 0.62 Lbs.



Dim/Info:
82" Long

For Models: FITS SEVERAL MODELS

A-1750002M1 Gasket, Head Cover 0.14 Lbs.



Dim/Info:
5

For Models: (T020, T030, T035, 135, 150, 230, 235, 35 ALL Gas)

A-731273M1 Gasket, Head Cover 0.08 Lbs.



For Models: (203, 35, 50 ALL W/ A3.152 PERKINS DIESEL ENG.)

Engine Related Parts

A-740760M91 Cover, Valve 2.50 Lbs.
Used on Perkins A3.152 Gas & AD3.152, T3.152.4 Diesel Engines
Replaces: Perkins# 37188571

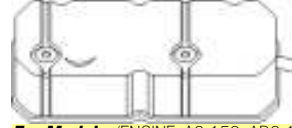

For Models: (ENGINE: A3.152, AD3.152, D3.152), 135 W/ Perkins Dsl. Eng. SN 152UA340545D>, 135 W/ Perkins Gas Eng. SN 152UA25847A>, 150 W/ Perkins Dsl. Eng. SN 152UA340545D>, 150 W/ Perkins Gas Eng. SN 152UA25847A>, 230, 231, 235, 240, 240P, 240S, 245, 250, 253, 263, 360, 20 W/ Perkins Dsl. Eng. SN 152UA340545D>, 20 W/ Perkins Gas Eng. SN 152UA25847A - 152UA26775A, 20C, 20D, 20E, 20F, 30B, 30D, 30E, 30H, 40 W/ Perkins Dsl. Eng. SN 152UA340545DL>, 40E, 2500 Forklift W/ Perkins Dsl. Eng. SN 152UA340545D>

A-180104M1 Gasket, Exhaust Pipe 0.02 Lbs.



Dim/Info:
5

For Models: (T035, 35 ALL W/ CONTINENTAL ENGINE)

A-0826232 Bolt, Exhaust Manifold 0.05 Lbs.

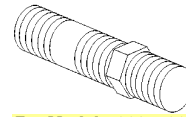

For Models: 1105, 1135, 135, 150, 20C, 20D, 20F, 200 SERIES, 202, 203, 205, 2135, 2200, 230, 235, 240, 245, 25, 250, 2500, 2802, 30B, 30D, 30E, 30H, 35, 356, 4500, 50, 65, 811, 8590

A-734700M1 Manifold, Exhaust 7.44 Lbs.
Replaces: 37781321



For Models: 180, 255, 265, 275, 50C

A-734921M1 Manifold, Exhaust 6.10 Lbs.
Used w/ (2) A-735016M1 & (1) A-180104M1 Gaskets
Replaces: Perkins# 37781351



For Models: 135 All Diesel / Perkins Gas SN <152UA263A, 150 Diesel / All Horiz. Exhaust / Vertical Exhaust SN <9A15748, 230 Diesel SN <9A293592, 235 Diesel, 245 Diesel Early Production, (20, 203, 205 ALL Diesel), 20C Diesel SN <9A293592, (2135, 30B, 30D ALL Diesel)

A-37781341 Elbow, Exhaust (180°) 7.36 Lbs.
Replaces: 734874M1



For Models: 135 SN <UA274551 W/ AD3.152 PERKINS ENGINE, (135, 148 ALL W/AD3.152 ENG), 154-4, 154-4S, 254 W/ AD3.152 PERKINS ENGINE, 254-4, 20D, 20F, 20F W/ AD3.152 PERKINS ENGINE, 30E, 30E W/ AD3.152 PERKINS ENGINE, 30H, 30H W/ AD3.152 PERKINS ENGINE, 4830FC, 5830, 5830FC, 5860, 5870







A-898011M1 Elbow, Exhaust (180°) 4.34 Lbs.



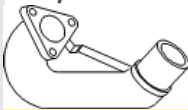

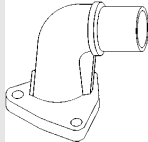
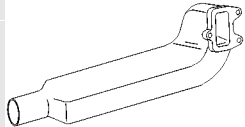
For Models: FE35, 148, FE135 CONVENTRY, 35 W/ A3.152 ENG, 135 W/AD3.152 ENG

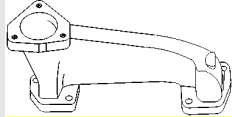
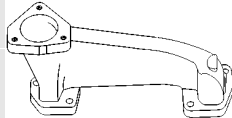
- ALLIS CHALMERS
- CASE-IH
- CATERPILLAR
- CLARK
- DEUTZ
- FIAT
- FORD / NEW HOLLAND
- GEHL
- HYSTER
- IMT
- INGERSOLL RAND
- JACOBSEN
- JCB
- JOHN DEERE
- LANDINI
- LEYLAND
- LINCOLN ELECTRIC
- MASSEY FERGUSON
- MELROE
- MICHIGAN
- OWATTONA
- PERKINS USA
- RENAULT
- SULAIR CORP
- VERMEER
- WHITE/ OLIVER
- ZETOR

Engine Related Parts

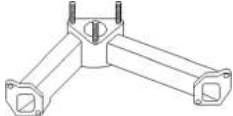
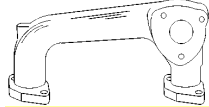
ALLIS CHALMERS	A-897913M1	Elbow, Exhaust	3.25 Lbs.
CASE-IH			
CATERPILLAR	<i>For Models:</i> 165 UK W/ A4.212 Eng. SN <59521, (175 UK, 178 ALL SN <745974)		
	A-897914M1	Elbow, Exhaust	6.82 Lbs.
	<i>Replaces:</i> 897047M1		
CLARK			
DEUTZ	<i>For Models:</i> 165 UK W/ AD4.203 Engine		
FIAT	A-1693855M1	Elbow, Exhaust (90°)	2.96 Lbs.
	<i>Replaces:</i> 1865534M1		
FORD / NEW HOLLAND			
GEHL	<i>For Models:</i> 130, (135, 148, 240, 250 ALL W/AD3.152 ENG)		
HYSTER	A-1862807M1	Elbow, Exhaust (90°)	3.94 Lbs.
IMT			
INGERSOLL RAND	<i>For Models:</i> 24, 270, 275, 283, 298, 362, (168, 175, 178, 185, 188 ALL A4.236 / A4.248), 165 W/A4.212 ENG, (290, 575, 590 ALL W/ENG TYPES A4.236 A4.248 ALL W/EXHAUST OUTSIDE HOOD), 265S		
JACOBSEN	A-533446M2	Elbow, Exhaust	10.84 Lbs.
JOHN DEERE			
LANDINI	<i>For Models:</i> 265, (255, 275, 50C, 50D ALL ALL W/A4-236 / A4-248 DSL ENG)		
LEYLAND	A-507629M1	Elbow, Exhaust	6.94 Lbs.
LINCOLN ELECTRIC			
	<i>For Models:</i> 165 ALL W/DSL ENG, 30 IND ALL W/DSL ENG, 3165 TURF, ALL W/ DSL ENG		
MASSEY FERGUSON	A-733206M1	Elbow, Exhaust (90°)	9.98 Lbs.
	<i>Replaces:</i> 736206M1, 37781781		
MELROE			
MICHIGAN	<i>For Models:</i> 11, 184-4, 220, 24, 25, 270, 283, 290, 31, 362, 50E, 50H, 60, 60H, 6500, 6800H, (168, 178, 185, 188 ALL ALL W/ENG TPYE A4.236 / A4.248), 165 W/ 165 A4.236 ENGINE, 175 SN 644000916->		
OWATTONA	A-736218M1	Manifold, Exhaust	7.00 Lbs.
PERKINS USA			
RENAULT	<i>For Models:</i> 203, 205, 35 W/A3.152 ENG		
SULAIR CORP	A-735040M1	Gasket, Exhaust Manifold	0.02 Lbs.
VERMEER			
	<i>For Models:</i> 165, 30, 3165		
WHITE/OLIVER			
ZETOR			

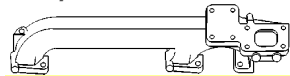
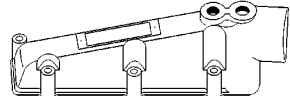
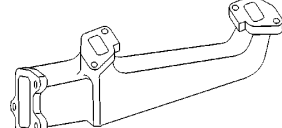
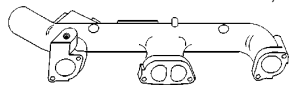
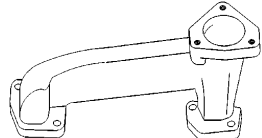
	A-735826M1	Manifold, Exhaust	6.83 Lbs.
			
	<i>For Models:</i> 174-4S, 178 S/N <UA36359, 184-4, 261, 274-4, 282, 294-4, (374S, 374V, 384S, 394S ALL S/N <D03066)		
	A-731267M1	Manifold, Exhaust	6.70 Lbs.
	<i>Replaces:</i> 37781251		
			
	<i>For Models:</i> 203, 205, 35 W/A3.152 ENG		
	A-7000805M1	Elbow, Exhaust	2.68 Lbs.
			
	<i>For Models:</i> 231, 240P W/ DSL ENG.		
	A-3637350M1	Manifold, Exhaust	9.58 Lbs.
	<i>Replaces:</i> 3778C003		
			
	<i>For Models:</i> 253, 360, 40E, 6070		
	A-734864M1	Manifold, Intake	1.06 Lbs.
	<i>Replaces:</i> 37786301		
			
	<i>For Models:</i> 135, 150, 20, 20C, 20D, 20F, 203, 205, 2135, 2200, 230, 235, 240, 245, 2500, 30B, 30D, 30E, 40, 4500, 50		
	A-741764M1	Manifold, Exhaust	11.58 Lbs.
	<i>Replaces:</i> 37781051		
			
	<i>For Models:</i> (50C, 50D ALL W/DSL ENG), 255 W/ 4.236 Diesel Engine Only, (265, 275 ALL W/DSL ENG)		
	A-37787654	Manifold, Intake	4.38 Lbs.
			
	<i>For Models:</i> 24, 25, 255, 265, 270, 275, 283, 285, 290, 362, 50C, 50D, 50E, 50H, 60H, 6500H, 6800H		
	A-740221M1	Manifold, Exhaust	7.28 Lbs.
	<i>Replaces:</i> 37781571		
			
	<i>For Models:</i> 20D, 231, (135, 148, 240, 250 ALL W/AD3.152 ENG)		

Parts are not original equipment parts and are not sponsored, affiliated, or otherwise connected with any major brand.

Engine Related Parts

Parts are not original equipment parts and are not sponsored, affiliated, or otherwise connected with any major brand.

A-732813M1 Manifold, Exhaust 12.82 Lbs.
For direct injection diesel engines only. Horizontal mounting flanges.
Replaces: 37781720

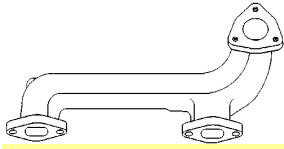

For Models: 302, 304, 356, 50, 50A, 65

A-1865533M1 Elbow, Exhaust 2.19 Lbs.



For Models: 135, 20D, 240, 250

A-673511M91 Elbow, Exhaust 4.40 Lbs.
For horizontal exhaust
Replaces: 828194M91

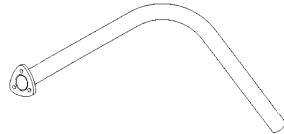

Dim/Info:

A: 3-Bolt Inlet I.D.
B: 12" Vertical Length
C: 34" Horizontal Length
D: 1 3/4" Outlet O.D.

For Models:

A-824245M1 Elbow, Exhaust 4.36 Lbs.

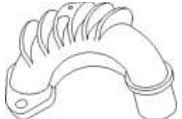

For Models: T035 W/ VERTICAL EXHAUST, FE35 W/ 23C DIESEL ENGINE & VERTICAL EXHAUST

A-890312M91 Elbow, Exhaust 3.98 Lbs.

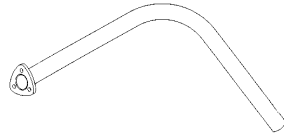

For Models: FE135, FE35, 135

A-899130M1 Elbow, Exhaust 4.60 Lbs.
Replaces: 640010M1

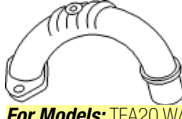

For Models: TEA20 W/ 80MM Or 85MM Engine, TED20 W/ 85MM Engine, (FE35, 135 UK ALL W/ 87MM Engine)

A-740695M1 Adapter, Exhaust Outlet 7.10 Lbs.
Used w/ A-3609201M1 exhaust sleeve
Replaces: Perkins#'s 37731881, 37738631; MF# 741054M1; White# 30-3159027



For Models: 1105, 1135

A-735016M1 Gasket, Exhaust Manifold 0.02 Lbs.
Replaces: 36862143



Dim/Info:

10

For Models: 135, 135 UK, 150, 154-4, 154-4S, 20, 200 SERIES, 203, 205, 20C, 20D, 20E, 20F, 2135, 2200, 2244, 230, 231, 235, 240, 245, 250, 2500, 254-4, 30, 30B, 30D, 30E, 30H, 350, 40, 40E, 4500, 5500, 5830, 5830FC, 5860, 5870, 6030FC

A-735040M1 Gasket, Exhaust Manifold 0.02 Lbs.



Dim/Info:

2

For Models: (165, 255, 30, 3165, 40B ALL Diesel)

A-194742M1 Gasket, Exhaust Elbow 0.04 Lbs.
Replaces: 1822726M1

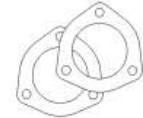

Dim/Info:

5

For Models: (30D, 50, 50B, 50D, 50E, 168, 265, 275 ALL W/ A4.212 OR AD4.236 PERKINS ENGINES), (60H, 185, 188, 290, 690 ALL W/ A4.248 PERKINS ENGINE), (1014, 1114 ALL W/ A6.354 PERKINS ENGINE), (165, 565, 575 ALL SN 212UA78664> W/ A4.212 OR AD4.236 PERKINS ENGINES), 178 SN 745974> W/ A4.248 PERKINS ENGINE

A-3640488M1 Gasket, Exhaust (Steel) 0.04 Lbs.
Replaces: 827877M1



Dim/Info:

5

For Models: 135, 148, 150, 154-4, 154-4S, 165, 180, 230, 231, 235, 240, 240P, 245, 250, 254-4, 255, 290, 35, 350, 50, 65, 765, FE135, FE35, 300, 20, 20C, 20D, 20F, 30, 30B, 30D, 30E, 30H, 32, 38, 40B, 50A, 200 SERIES, 203, 205, 302, 304, 356, 2135, 2244, 2500, 3165, 4500, 4830FC, 5830, 5830FC, 5860, 5870

A-734701M1 Gasket, Exhaust (Steel) 0.02 Lbs.
Replaces: 36822111



Dim/Info:

5

For Models: 1745, 175, 255, 2640, 283, 290, 3505, 3525, 470, 50C, 50D, 50E, 50H, 60, 690, 699, 750, 850, 855, 910 ENG

A-742106M91 Flywheel w/ Ring Gear 86.00 Lbs.
Replaces: 41117084, 41112565



Dim/Info:

Ring Gear

For Models: 261, 270, 275, 282, 283, 290, 690, 165 UK W/ A4.212, 12" CLUTCH, (275 UK, 375, 50F ALL W/ A4.236), 362 W/ A4.236, BUILD LIST: LD31234, 50E W/ POWER SHUTTLE, 4.236 BUILD LIST: LD31114 & LD31178, 365 SN: < B18009, W/ A4.236, 175 UK W/ A4.248, 12" CLUTCH, 283 UK W/ 1004.42 GREEN OR A4.248, (290 UK, 383 ALL W/ A4.248), 390, 50E, 670 DSI

A-3819667M91 Flywheel, W/ Ring Gear 57.00 Lbs.



For Models: 390 SN <-B18008 W/ A4.248 ENG. W/ BUILD # LF31186 OR LF31235, (390T, 393, 398 ALL W/ AT4.236 ENG.), 4243 W/ 1004.4 ENG., 4245 W/ 1004.4 ENG. W/O POWER SHUTTLE & W/O WET CLUTCH, 4253 W/ 1004.4 ENG., (4255, 4265 ALL W/ 1004.4 ENG. W/O POWER SHUTTLE & W/O WET CLUTCH), (4345, 4355 ALL W/ 1004.4 ENG. W/O POWER SHUTTLE)

A-1750034M1 Ring Gear, Flywheel 2.54 Lbs.



Dim/Info:

145 Teeth
14.685" O.D.
13.680" I.D.
.500" Thick

For Models: 135, 150, TE20, (T020, T030, T035, 135, 150, 165, 175, 180, 35, 50, 65 ALL W/ CONT. GAS MOTOR)

ALLIS
CHALMERS

CASE-IH

CATERPILLAR

CLARK

DEUTZ

FIAT

FORD / NEW
HOLLAND

GEHL

HYSTER

IMT

INGERSOLL
RAND

JACOBSEN

JCB

JOHN
DEERE

LANDINI

LEYLAND

LINCOLN
ELECTRIC

MASSEY
FERGUSON

MELROE

MICHIGAN

OWATTONA

PERKINS USA

RENAULT







SULAIR CORP







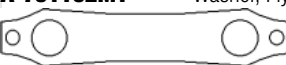

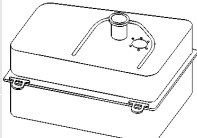
VERMEER

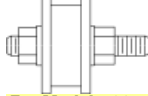
WHITE/
OLIVER

ZETOR

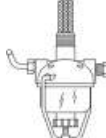
Engine Related Parts

ALLIS CHALMERS	A-731008M1	Ring Gear, Flywheel	4.14 Lbs.
	<i>Replaces:</i> 410236		
CASE-IH		<i>Dim/Info:</i> 115 Teeth 13 13/32" I.D. For MF65 & MF165	
CATERPILLAR	<i>For Models:</i> 154-4, 154-4S, 165, 180, 184-4, 230, 235, 245, 254-4, 255, 274-4, 282, 294-4, 3050, 1745, 20, 20C, 24, 30, 30B, 30D, 30H, 202, 203, 205, 300, 302, 304, 2200, 3060, 3070, 31, 3165, 35, 356, 40, 40B, 40E, 50, 50A, 50C, 50D, 5830, 60, 65, 670, 690, 7830, 8530F, 8830, (135, 148, 158, 168, 175, 178, 185, 188, 240, 250, 2640, 265, 275, 3080, 285, 3090, 350, 355, 565, 765 ALL ALL W/ENG A3.152-AD3.152-A4.192-A4.203-AD4.203-A4.236-A4.248), 2135, 220, 550, 300		
CLARK			
DEUTZ			
FIAT	A-825149M1	Ring Gear, Flywheel	3.32 Lbs.
FORD / NEW HOLLAND		<i>Dim/Info:</i> 13-3/8" I.D. 14-5/8" O.D. 145 Teeth	
GEHL	<i>For Models:</i> TEA20 SN <200000 W/ 6 Volt Starter Motor		
HYSTER	A-731988M1	Ring Gear, Flywheel	4.40 Lbs.
IMT		<i>Dim/Info:</i> 122 Teeth 14.312" I.D.	
INGERSOLL RAND	<i>For Models:</i> SUPER 90, 1080, 1085, 1100, 1105, 1130, 1135, 285, 298, 698		
JACOBSEN	A-826049M1	Ring Gear, Flywheel	4.75 Lbs.
JCB	<i>For Models:</i> FE35 W/ 23C Engine		
JOHN DEERE	A-738588M1	Gear, Ring	4.50 Lbs.
	<i>Replaces:</i> 730407, 31162121		
LANDINI		<i>Dim/Info:</i> 126 Teeth	
LEYLAND	<i>For Models:</i> (INDUSTRIAL/CONSTRUCTION: 80), A4-236, A6.354.4, T4-236, T6.354-4		
LINCOLN ELECTRIC	A-731192M1	Washer, Flywheel Bolt Tab	0.03 Lbs.
		<i>Dim/Info:</i> 10	
MASSEY FERGUSON	<i>For Models:</i> 40 INDUSTRIAL W/ A3.152, AD3.152 OR AT3.152 PERKINS ENGINES, (135, 148, 240, 250, 254, 30E, 30H, 35, 363 ALL W/ A3.152, AD3.152 OR AT3.152 PERKINS ENGINES), (155, 165, 168, 175, 178, 185, 188, 260, 265, 274, 275, 285, 290, 30D, 373, 377, 383, 387, 393, 397, 398, 50, 565, 575, 65, 690, 698, 765 ALL W/ A4.192, AD4.203, A4.212, A4.236 OR A4.248 PERKINS ENGINES), (1014, 1100, 1200, 1250, 2640, 2645, 2680, 2685, 2720, 2725, 3090, 3630, 3650, 3080 ALL W/ A6.354 OR A6.372 PERKINS ENGINES)		
MELROE			
MICHIGAN			
OWATTONA	A-1873971M92	Cable, Tachometer	0.05 Lbs.
		<i>Dim/Info:</i> 68 1/4" Total Length	
PERKINS USA	<i>For Models:</i> 282, 298		
RENAULT	A-579012M92	Tank, Fuel	27.18 Lbs.
SULAIR CORP			
VERMEER	<i>For Models:</i> 255 S/N 9A282760->, 265 S/N 9A282759->, 275 S/N 9A284893->, 40B S/N 9A282759->, 50C S/N 9A282766->, 50D		
WHITE/OLIVER			
ZETOR			

A-883623M1	Bushing, Fuel Tank Mounting	0.16 Lbs.
		
<i>For Models:</i> 165, 168, 175, 178, 185, 188, 265, 270, 275, 285, 290, 298, 30D, 30E, 392S, 50, 50B, 50D, 50E, 60H, 283 UK MODEL		
A-1876534M91	Cap, Fuel (Vented)	0.14 Lbs.
This cap locks on the outside of the fuel tank neck		
<i>Replaces:</i> 828583M91, 1698042M91		
		
<i>For Models:</i> 1080, 148, 155, 158, 168, 185, 188, 20, 20B, 20D, 20E, 20F, 231, 240, 240P, 250, 253, 260, 261, 270, 283, 290, 298, 30D, 30E, 30H, 35, 40, 40E, 50, 50B, 50D, 50E, 50F, 50H, 565, 575, 590, 595, 60H, 670, 675, 690, 698, 698T, 699, FE35, 135 UK, (6500H, 6800 ALL FORK LIFT), (COMBINE: 550, 560 UK)		
A-1695732M1	Cap, Fuel	0.38 Lbs.
		
<i>For Models:</i> 340, 342, 350, 352, 355, 362, 365, 372, 375, 382, 382N B18009>, 390, 390T, 398, 399		
A-3041489M4	Cap, Filler	0.40 Lbs.
		
<i>For Models:</i> 2620, 2625, 2640, 2645, 2680, 2685, 2720, 2725, 3050, 3060, 3065, 3070, 3080, 3090, 3095, 3115, 3125, 3140, 3630, 3645, 3650, 3655, 6160, 6170, 6180		
A-180141M1	Bowl Assembly, Sediment w/ Short Bowl	0.26 Lbs.
	<i>Dim/Info:</i> 2" Bowl	
<i>For Models:</i> F40, T035, 202 SN <309328, 203 SN <119700213, 204 SN <343891, 304 SN <119750210, 35, 356 SN <670001084, 50, 65, 85, 88		
A-1001515M1	Bail & Nut, Sediment Bowl	0.10 Lbs.
Used w/ 2" Bowl		
		
<i>For Models:</i> F40, T035, 35, 35 INDUSTRIAL, 50, 65, 85, 88, 203 SN <119700213, 202 SN <309328, 204 SN <343891, 356 SN <670001084, 304 SN 119750210		
A-17C4857	Bail & Nut, Sediment Bowl	0.10 Lbs.
For use w/ tall bowl.		
		
<i>For Models:</i> (INDUSTRIAL/CONSTRUCTION: 40)		
A-17C52	Bowl & Gasket, Fuel Sediment	0.14 Lbs.
Small Bowl		
		
A-17C51	Bowl, Fuel	0.10 Lbs.
<i>For Models:</i> 202 SN <309328, 203 SN <119700213, 204 SN <343891, 304 SN <119750210, 35, 35 INDUSTRIAL, 356 SN <670001084, 50, 65, 85, 88, F40, T035		

Parts are not original equipment parts and are not sponsored, affiliated, or otherwise connected with any major brand.

Parts are not original equipment parts and are not sponsored, affiliated, or otherwise connected with any major brand.

Engine Related Parts

A-1004496M1 Gasket, Sediment Bowl (10 pack) 0.01 Lbs.



Dim/Info:
2.125" O.D.
Pkg Qty 10

For Models: 1100, 1130, 135, 150, 165, 200 SERIES, 2135, 2200, 2500, 302, 303, 304, 3165, 333, 35, 35 TURF, 35 UTILITY, 44, 444, 44-6, 50, 55, 555, 55K, 65, 85, 88, SUPER 90, TE20, TEA20, TO20, TO30, TO35, (COMBINE: 205, 300, 410, 510, 540, 550, 70, 72, 750, 760, 80, 82, 90, 92)

A-505472M91 Strainer, Fuel Assembly (Tall Bowl) 0.71 Lbs.



Dim/Info:
2 1/8" Dia. X 2.370" Long
Glass Bowl

A-17C40 Sediment Bowl 0.30 Lbs.

For Models: 135 W/ Continental Gas Engine SN 64104694> & All Perkins Gas Eng, 150 W/ Continental Gas Engine, (165, 175, 180 ALL W/ Continental & Perkins Gas Engines), 20 W/ Perkins Gas Engine, (202, 204 ALL W/ Gas Engine / Late Production), 2135 W/ Gas Engine SN 646001190>, 30 W/ Perkins Gas Engine, 3165 W/ Continental Gas Engine

A-376524X1 Sleeve, Fuel Line (10 pack) 0.01 Lbs.



Dim/Info:
3/16" X 5/16" X 3/16"

For Models: 1080, 1100, 1105, 1130, 1135, 135, 150, 154-4, 154S, 165, 175, 178, 180, 240, 254-4, 283, 290, 3060, 3075, 3095, 3115, 3120, 3120T, 3125, 3140, 362, 3635, 3645, 3655, 375, 390, 390T, 394S, 398, 399, 4215, 4220, 4225, 4235, 4240, 4245, 4255, 4260, 4270, 4325, 4335, 4345, 4355, 4360, 4370, 6130, 6140, 6150, 6160, 6170, 6180, 6190, 6235, 6245, 6255, 6260, 6265, 6270, 6280, 6290, 65, 690, 698, 699, 765, 8110, 8120, 8210, 8220

A-890322M92 Pipe, Fuel 0.07 Lbs.



For Models: 135 UK W/ AD3.152 Engine SN <152UA38571D, 35 W/ A3.152 Engine

A-892130M93 Pipe, Fuel 0.11 Lbs.
Replaces: 890324M93, 892130M92

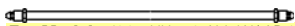

For Models: (165 UK, 50 ALL W/ AD4.203 Engine), (FE35, 35X ALL W/ A3.152 Engine)

A-520948M91 Cap, Fuel 0.16 Lbs.



For Models: 1080, 1100, 1130, 1150, 135, 150, 165, 165 UK, 175, 175 UK, 178, 180, 20, 203, 205, 2135, 30, 302, 304, 31, 3165, 35, 50, 50A, 65, 85, 88, SUPER 90, TE20, TEA20, TO20, TO30, TO35

A-1851653M91 Valve, Fuel Tap 0.30 Lbs.

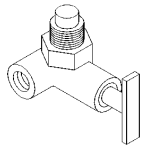

For Models: FE35, 165, 255, 2640, 3505, 3525, 3545, 50, 65, 356 SHOVEL, BLADE FORELIFT, (158, 285, 765 ALL W/AD4.203 ENG), 350 W/3.152 ENG

A-1694985M92 Valve, Fuel Tap 0.27 Lbs.

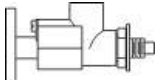

For Models: (275, 30D, 362, 365, 372, 375 ALL W/ A4.236 ENGINE), (382, 390 ALL W/ A4.248 ENGINE), (390T, 398 ALL W/ AT4.236 ENGINE), (230, 340, 342, 350, 352 ALL W/ AD3.152 ENGINE), (253, 355, 360 ALL W/ AT3.152.4 ENGINE)

A-898540M91 Valve, Fuel Tap 0.26 Lbs.

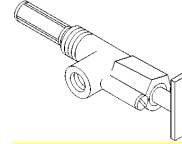

For Models: 135, 148, 20D, 20F, 230, 240, 240P, 250, 30E, 30H, 40E, 550 ALL W/ AD3.152 ENG, FE135 CONVENTRY, 300 CRAWLER, 111 LOADER

A-898580M91 Valve, Fuel Tap 0.31 Lbs.

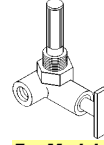

For Models: 270, 282, 298, 50E, 50F, 50H, 60H, (6500, 6800H ALL FOKLIFT), (165, 168, 175, 178, 185, 188, 265, 275, 285, 290, 565, 575, 590, 675, 690 ALL W/ ENG TYPES A4.212 A4.236 A4.248)

A-1884857M91 Pump, Fuel Lift Transfer 1.21 Lbs.

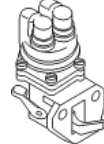

For Models: 35, 35X, FE35 SN SJ37181E>, FE35, TO35

A-4222174M91 Pump, Fuel Lift Transfer 1.20 Lbs.
Replaces: 2641A059, 3637414M91, 1446146M91, 1641103M91, 893159M91, 890986M91, 2641314, 2641304, 2641305



For Models: 130 W/ A4.107 Engine

A-4223583M91 Pump, Fuel Lift Transfer 1.40 Lbs.
Replaces: 3637729M91, 2641A056, 2641715, 2641710



For Models: 1114 SN <U711699L W/ A6.354.4 Engine

A-826154M91 Pump, Fuel Lift Transfer 1.31 Lbs.



For Models: TE20, FE35 SN <SJ37180E

A-3637290M1 Pump, Fuel Lift (4 Hole Mount) 1.30 Lbs.
Replaces: 2641711, 2641725, 3637300M1







Dim/Info:
Pump Has 4 Hole Mounting For Models w/ A4-236 & A4-248 Diesel Engines.

For Models: A4-236, 165, 168, 175, 184-4, 255, 50E, 31 ENGINE SN 236UA57083>, A4-318 PERKINS ENG, 274-4 SN <221N00936, 294-4 SN <223000321, 185 W/A4-212, 261

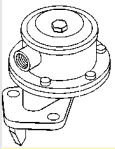
- ALLIS CHALMERS
- CASE-IH
- CATERPILLAR
- CLARK
- DEUTZ
- FIAT
- FORD / NEW HOLLAND
- GEHL
- HYSTER
- IMT
- INGERSOLL RAND
- JACOBSEN
- JCB
- JOHN DEERE
- LANDINI
- LEYLAND
- LINCOLN ELECTRIC
- MASSEY FERGUSON
- MELROE
- MICHIGAN
- OWATTONA
- PERKINS USA
- RENAULT
- SULAIR CORP
- VERMEER
- WHITE/ OLIVER
- ZETOR

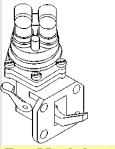
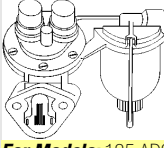
Engine Related Parts

ALLIS CHALMERS	A-4222104M91 Pump, Fuel Lift Transfer <i>Replaces:</i> 3637287M91, 881303M92, 2641465, 2641478, 1447381M91	1.70 Lbs.
CASE-IH		
CATERPILLAR		
CLARK	<i>For Models:</i> AD4-203, AD4-236 DSL, 175 SN<236UA57083, (180, 31 ALL SN<236UA57265)	
DEUTZ	A-1446951M91 Pump, Fuel Lift Transfer <i>Replaces:</i> 3641400M91, 312765497	2.54 Lbs.
FIAT		
FORD / NEW HOLLAND		
GEHL	<i>For Models:</i> 265 S/N 9A349239>, 396, 399, 699, 1745, 2640, 2675, 2705, 3080, 3090, 3095, 3120, 3120T, 3125, 3140, 3505, 3525, 3545, 3630, 3645, 3650, 3655, 3660, 6180, 8120, 300, 6500, 6500, 550, 750, 760, 850, 855, 860, 865, 910 ENG	
HYSTER	A-2641808 Pump, Fuel Lift (4 Hole Mount) <i>Replaces:</i> 3637292M91, 4222090M91	1.18 Lbs.
IMT	<i>Dim/Info:</i> 4 Hole Mount Eng SN <152UA535849G	
INGERSOLL RAND		
JACOBSEN	<i>For Models:</i> 135 E-SN ENDING IN D, 135 E-SN ENDING IN DL, 150 E-SN ENDING IN D, 154-4, 154-4S, 20, (20, 200, 203, 205 ALL E-SN ENDING IN D), 20B, 20C, 20C E-SN ENDING IN DS, 20C ENG SN ENDING IN DSL, 20D, 20F, (2135, 2200, 2244 ALL E-SN ENDING IN D), 230, 230 E-SN ENDING IN DL, 231, 235 E-SN ENDING IN D, 235 E-SN ENDING IN DL, 235 E-SN ENDING IN DS, 235 ENG SN ENDING IN DSL, 240, 243, 245, 245 E-SN ENDING IN DS, 245 ENG SN ENDING IN DSL, 250, 250 ENG SN ENDING IN DSL, 2500 E-SN ENDING IN D, 253, 254-4, 30B,	
JCB		
JOHN DEERE		
LANDINI	A-4222094M91 Pump, Fuel Lift Transfer <i>Replaces:</i> 890960M91, 2641406, 35273, 885363M91	0.95 Lbs.
LEYLAND		
LINCOLN ELECTRIC		
MASSEY FERGUSON	<i>For Models:</i> 135 AD3-152 ENG SN <-152UA46497D, 135 UK AD3-152 ENG SN <-152UA38571D, (150, 203, 205, 2135, 2200, 2244, 2500 ALL AD3-152 ENG SN <-152UA46497D), 35, 35 UTILITY D3-152 ENG, 35FE, 35X, 50 Perkins Diesel	
MELROE	A-3637307M1 Pump, Fuel Lift (2 Hole Mount) <i>Replaces:</i> 886062M91, 2641311, 2641309	1.10 Lbs.
MICHIGAN		
OWATTONA		
PERKINS USA	<i>For Models:</i> 135 UK MODEL W/ AD3.152 ENG. SN 152UA38571D>, (154-4, 20, 235, 40, 4500 ALL W/ AD3.152 DIESEL ENGINE), (20E, 240, 30H ALL W/ AD3.152 DIESEL ENGINE SN <U635848G), (20C, 230, 245, 30B ALL W/ AD3.152 DIESEL ENGINE SN <U635849G), (150, 203, 205, 2135, 2200, 2500 ALL W/ AD3.152 DIESEL ENGINE SN 152UA46497D>), 550 W/AD3-152 PERKINS ENG, 135 W/ AD3.152 DIESEL ENGINE SN 152UA46497D>	
RENAULT		
SULAIR CORP		
VERMEER		
WHITE/OLIVER		
ZETOR		

A-3637338M91 Pump, Fuel Lift w/ Sediment Bowl 2.40 Lbs.
Replaces: 2641A065, 2641345, 4222452M91, 890955M91, 892630M91



Dim/Info:
Use on build no. JD22028

For Models: 165, 65, 356 E-SN <2820092, 365 E-SN <2939035 NOT ENDING W/ DL, (255, 300, 3165, 40B, 50 ALL E-SN 29C1085>), 304 E-SN 2939036-29C1084, 765 W/PERKINS AD4-203 / NON MF A4-192 ENG

A-3637286M91 Pump, Fuel Lift w/o Sediment Bowl 1.86 Lbs.
Replaces: 2641328, 2641333, 1446155M91, 1447693M91, 3639013M1, 3637286M1, 4222107M91, 886100M91

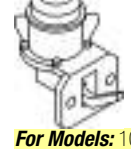

Dim/Info:
Use on build no. JD22458/
JD22533

For Models: 1085, 285, 540, (165, 255, 30, 40B, 50, 50A ALL W/AD4-203 ENG), (302, 3165, 356 ALL W/SN ENG 29F4249>, AD4-203 ENG), (1080, 298, 698, 70 ALL W/SN 31BUA1753-> ENG / A4-410 ENG)

A-3637309M1 Pump, Fuel Lift (2 Hole Mount) 2.28 Lbs.
Replaces: 2641A064, 2641372, 892632M91

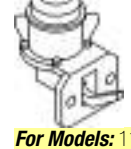

For Models: 1105, 750, 1100 E-SN <354UA10361, 1130 E-SN <354UA3355T, 760 E-SN UA48970I>, 1135 W/A6-354 PERKINS ENG

A-4224451M91 Pump, Fuel Lift 1.20 Lbs.
Replaces: 4222106M91, ULPK0034, 3641308M91, 3639696M1

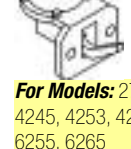

Dim/Info:
Pump Has 4 Hole Mounting

For Models: 271, 281, 281X, 281XE, 283 UK, 4225, 4233, 4235, 4240, 4243, 4245, 4253, 4255, 4265, 4325, 4335, 4345, 4355, 6140, 6150, 6235, 6245, 6255, 6265

A-1883344M92 Repair Kit, Fuel Pump 0.29 Lbs.

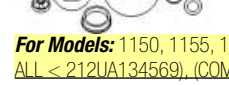

For Models: 1150, 1155, 165, 165 UK, 175, 175 UK, 178, 180, 220, 31, (50, 50B ALL < 212UA134569), (COMBINE: 760)

A-3774471M1 Elbow, Exhaust 4.12 Lbs.

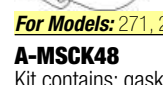

For Models: 271, 281, 283 UK, 283 UK MODEL ONLY

A-MSCK48 Carburetor Kit, Basic (Marvel-Schebler) 0.50 Lbs.
Kit contains: gaskets & float valve only.

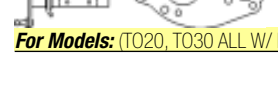

For Models: (TO20, TO30 ALL W/ MARVEL SCHEBLER CARBURETOR - TSX458)

Parts are not original equipment parts and are not sponsored, affiliated, or otherwise connected with any major brand.

Parts are not original equipment parts and are not sponsored, affiliated, or otherwise connected with any major brand.

Engine Related Parts

A-MSCK63 Carburetor Kit, Complete 0.50 Lbs.
Kit contains parts necessary for major carburetor overhaul.

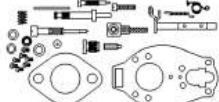

For Models: (T020, T030 ALL W/ MARVEL SCHEBLER CARBURETOR - TSX458)

A-MSCK62 Carburetor Kit, Complete 0.50 Lbs.
Kit contains parts necessary for major carburetor overhaul.

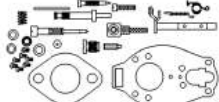

For Models: (TE20, T020 ALL W/ MARVEL SCHEBLER CARBURETOR - TSX361A)

A-VPD3651 Carburetor Kit 0.50 Lbs.



For Models: TEA20 80mm, TEA20 85mm

A-17C661 Carburetor Kit, Basic 0.45 Lbs.
Kit contains gasket set, needle & seat.

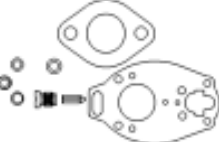

For Models: T020, T030, T035, 135, 150, 35, 50

A-1751212M1 Elbow & Strainer, Carburetor 0.05 Lbs.



For Models: T035, 35, 50

A-15479A Needle & Seat, Carburetor 0.05 Lbs.

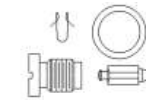

For Models: F40, TE20, T020, T030, T035, PONY, 135, 150, PACER, 20, 202, 204, 2135, 22, 2200, 2500, 30, 35, 50 MASSEY HARRIS & FERGUSON

A-ZCK27 Carburetor Kit, Basic (Zenith) 0.50 Lbs.
Kit contains float valve, adjusting needle, gaskets, seals, washers & float pin.

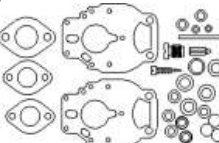

For Models: (135, 165, 35 ALL W/ PERKINS ENGINE & ZENITH CARBURETORS - 13338, 13316)

A-CCK02 Carburetor Kit, Basic (Carter) "Viton" 0.02 Lbs.
Basic carb. kits contain gaskets, float valve & throttle shaft.

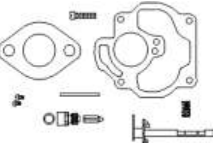

For Models: (202, 204, 2135, 35, 50, F40, T035 ALL W/ Carter Carb.#: UT2223S, UT2418S)

A-ZCK21 Carburetor Kit, Basic (Zenith) "Viton" 0.02 Lbs.
Basic carb. kits contain gaskets, float valve & throttle shaft.



For Models: (44, 444, 44K ALL W/ Zenith Carb.#: 62AJX9/10444, 62AJX/10279A, 10279B)

A-MSCK32 Carburetor Kit, Basic (Marvel-Schebler) 0.02 Lbs.
Basic carb. kits contain gaskets, float valve & throttle shaft. Used w/ OEM carb.#'s: 184845M91, 191960M91

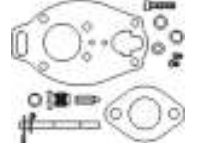

For Models: (85, 88 ALL W/ Marvel-Schebler Carb.#'s: TSX644, TSX786-1)

A-MSCK66 Carburetor Kit, Complete 0.50 Lbs.
Contains parts necessary for major carburetor overhaul.

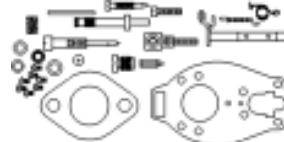

For Models: (F40, T035, 135, 150, 202, 204, 2135, 35, 50 ALL W/ MARVEL SCHEBLER CARBURETORS - TSX605, TSX683, TSX882)

A-MSCK55 Carburetor Kit, Basic (Marvel-Schebler) 0.50 Lbs.
Kit contains: gaskets, float valve & throttle shaft.

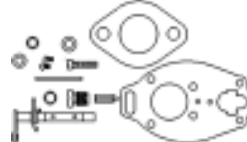

Dim/Info:
For Oem Carb.#'s:
181532M91, 183576M91,
194065M91, 533969M91

For Models: (F40, T035, 135, 150, 202, 204, 2135, 35, 50 ALL W/ Marvel Schebler Carb.#'s: TSX605, TSX683, TSX882)

A-MSCK39 Carburetor Kit, Basic (Marvel-Schebler) "Viton" 0.02 Lbs.
Basic carb. kits contain gaskets, float valve & throttle shaft.

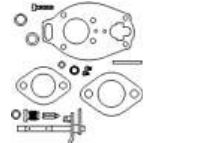

For Models: 165 W/ Marvel-Schebler Carb.#'s: TSX695, TSX884, 175 W/ Marvel-Schebler Carb.#'s: TSX893, TSX916, 65 W/ Marvel-Schebler Carb.#'s: TSX695, TSX884

A-MSCK38 Carburetor Kit, Complete (Marvel-Schebler) "Viton" 0.02 Lbs.
Complete carb. kit contains all parts necessary for major carb. overhaul. Used w/ OEM carb.#'s: 184301M91, 194603M92

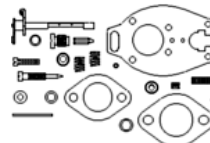

For Models: (165, 3165, 65 ALL W/ Marvel-Schebler Carb.#'s: TSX695, TSX884)





A-529737M91 Governor Assembly 1.78 Lbs.







For Models: (135, 150, 2135, 230, 235, 245, 35, 50, TE20, T020, T030, T035 ALL W/ Continental Engine)

- ALLIS CHALMERS
- CASE-IH
- CATERPILLAR
- CLARK
- DEUTZ
- FIAT
- FORD / NEW HOLLAND
- GEHL
- HYSTER
- IMT
- INGERSOLL RAND
- JACOBSEN
- JCB
- JOHN DEERE
- LANDINI
- LEYLAND
- LINCOLN ELECTRIC
- MASSEY FERGUSON
- MELROE
- MICHIGAN
- OWATTONA
- PERKINS USA
- RENAULT
- SULAIR CORP
- VERMEER
- WHITE/ OLIVER
- ZETOR

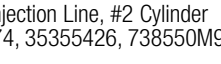
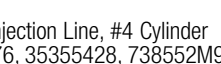
Engine Related Parts

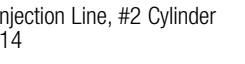
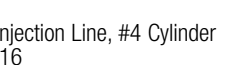
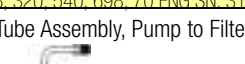
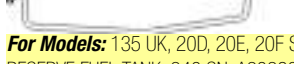
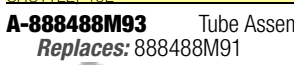
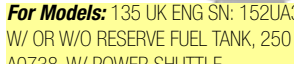
ALLIS CHALMERS	A-1750108M1	Seal, Governor Shaft	0.02 Lbs.
CASE-IH			
CATERPILLAR	For Models: T020, T030, T035, 135, 150, 230, 235, 245, 35, 50		
CLARK			
DEUTZ	A-FPL2100	Injection Line Set	0.70 Lbs.
FIAT	A-3638623M91	Injection Line, #1 Cylinder	0.30 Lbs.
FORD / NEW HOLLAND	A-3638624M91	Injection Line, #2 Cylinder	0.20 Lbs.
	A-3638625M91	Injection Line, #3 Cylinder	0.24 Lbs.
GEHL	For Models: 20, 230, (135, 150, 2200, 40 ALL ENG SN: 152UA138660D >), (135 UK, 240 ALL W/ AD3.152), 235 W/ ENG SN: ENDING IN "D" OR "DL", 20D, 30E W/ P.SHUT, 3.152 ENG BUILD LIST: CE31116, CE31182, CE31183, 30H W/ 3.152, BUILD LIST: CE31116, CE31138, CE31182, CE31183		
HYSTER			
IMT			
INGERSOLL RAND	A-FPL900	Injection Line Set (4 Cyl)	1.50 Lbs.
JACOBSEN	A-734194M91	Injection Line, #1 Cylinder	0.30 Lbs.
JCB	A-732899M91	Injection Line, #2 Cylinder	0.30 Lbs.
JOHN DEERE	A-732898M91	Injection Line, #3 Cylinder	0.40 Lbs.
LANDINI	A-735308M91	Injection Line, #4 Cylinder	0.30 Lbs.
LEYLAND	For Models: 50, 65, 165, (165 UK, 255 ALL W/ AD4.203), 3165, 30, 40B, 50A, 302, 304, (COMBINE: 300)		
LINCOLN ELECTRIC	A-735010M91	Line Assembly, Leak Off	0.15 Lbs.
MASSEY FERGUSON	For Models: 135, 135 UK ENG SN: < 152UA44618D, W/ AD3.152, 150 ENG SN: < 152UA44619D, 203, 205, 240 SN: N01001-A20286, ENG SN: < U732659L, W/ AD3.152, 240S, 2500 ENG SN: < 152UA44619D		
MELROE			
MICHIGAN	A-FPL2200	Injection Line Set (4 Cyl)	1.32 Lbs.
OWATTONA	A-734194M91	Injection Line, #1 Cylinder	0.30 Lbs.
PERKINS USA	A-732899M91	Injection Line, #2 Cylinder	0.30 Lbs.
	A-732898M91	Injection Line, #3 Cylinder	0.40 Lbs.
RENAULT	A-735308M91	Injection Line, #4 Cylinder	0.30 Lbs.
SULAIR CORP	For Models: 165, (165 UK, 255 ALL W/ AD4.203), 30, 302, 304, 3165, 40B, 50, 50A, 65 ENG SN: 2921733 >, (COMBINE: 300)		
VERMEER			
WHITE/OLIVER			
ZETOR			

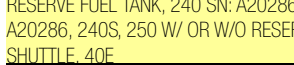
	A-739142M91	Injection Line, #1 Cylinder	0.30 Lbs.
	Replaces: 35355373, 738549M91		
	A-739143M91	Injection Line, #2 Cylinder	0.30 Lbs.
	Replaces: 35355374, 35355426, 738550M91		
	A-739144M91	Injection Line, #3 Cylinder	0.30 Lbs.
	Replaces: 35355375, 35355427, 738551M91		
	A-739145M91	Injection Line, #4 Cylinder	0.30 Lbs.
	Replaces: 35355376, 35355428, 738552M91		
For Models: (1080, 70 ALL ENG SN: < 318UA3659)			
	A-738913M91	Injection Line, #1 Cylinder	0.30 Lbs.
	Replaces: 35355413		
	A-738912M91	Injection Line, #2 Cylinder	0.30 Lbs.
	Replaces: 35355414		
	A-738911M91	Injection Line, #3 Cylinder	0.30 Lbs.
	Replaces: 35355415		
	A-738910M91	Injection Line, #4 Cylinder	0.30 Lbs.
	Replaces: 35355416		
For Models: 1080 ENG SN: 318UA3659 >, 1085, 285 TRACTOR SN: < 9A349239 ± 9B & 9A349239 >, 298, 320, 540, 698, 70 ENG SN: 318UA3659 >			
	A-888490M91	Tube Assembly, Pump to Filter	0.10 Lbs.
	For Models: 135 UK, 20D, 20E, 20F SN: < B0243, 240 SN: < N01001, W/ OR W/O RESERVE FUEL TANK, 240 SN: A20286 >, W/ CLASSIC PEDALS, 240 SN: N01001 - A20286, 240S, 250 W/ OR W/O RESERVE FUEL TANK, 30E SN: < A0738, W/ POWER SHUTTLE, 40F		
	A-888488M93	Tube Assembly, Pump to Filter	0.20 Lbs.
	Replaces: 888488M91		
	A-888482M91	Tube Assembly, Filter to Pump	0.15 Lbs.
	For Models: 135 UK ENG SN: 152UA38571D >, 20D, 20E, 240 SN: < N01001, W/ OR W/O RESERVE FUEL TANK, 250 W/ OR W/O RESERVE FUEL TANK, 30E SN: < A0738, W/ POWER SHUTTLE		
	A-883712M94	Tube Assembly, Tap to Lift Pump	0.10 Lbs.
	Replaces: 883712M92, 883712M93		
	For Models: 135 UK SN: 152UA38571D >, 20D, 20E, 20F, 240 SN: < N01001, W/ OR W/O RESERVE FUEL TANK, 240 SN: N01001 - A20286, W/ ERGONOMIC PEDALS, 240P, 250 W/ OR W/O RESERVE FUEL TANK, 30E, POWER SHUTTLE, 30H, 40F		

Parts are not original equipment parts and are not sponsored, affiliated, or otherwise connected with any major brand.

Parts are not original equipment parts and are not sponsored, affiliated, or otherwise connected with any major brand.

Engine Related Parts

A-884472M94 Tube Assembly, Tank to Thermostat 0.10 Lbs.
Replaces: 884472M92, 884472M93



For Models: 135 UK N. AMERICA EXCEPTED, 240 SN: < N01001, W/ RESERVE FUEL TANK, 250 W/ RESERVE FUEL TANK

A-884473M93 Tube Assembly, Tee Piece to Reservoir 0.10 Lbs.
Replaces: 884473M92



For Models: 135 UK, 20E, 20F, 240 SN: < N01001, W/ RESERVE FUEL TANK, 250 W/ RESERVE FUEL TANK, 30E SN: < A0738, W/ POWER SHUTTLE, (35, 35X ALL W/ A3.152)

A-888486M91 Tube Assembly 0.05 Lbs.



For Models: 135 UK, 20E, 20F, 240 SN: < N01001, W/ RESERVE FUEL TANK, 240 SN: A20286 >, W/ CLASSIC PEDALS, 240 SN: N01001 - A20286, 240S, 250 W/ RESERVE FUEL TANK, 30E SN: < A0738, W/ POWER SHUTTLE

A-899453M92 Tube Assembly, Fuel Gauge Bottom Half 0.15 Lbs.



For Models: 135 UK

A-899451M92 Tube Assembly, Fuel Gauge TOP HALF 0.05 Lbs.



For Models: 135 UK

A-887029M92 Tube Assembly, Fuel System 0.10 Lbs.

For Models: 165 UK SN: 556395 >, A4.212, (175, 178 ALL SN: 727909 >)

A-899717M91 Tube Assembly, Fuel System 0.20 Lbs.



For Models: 165 UK W/ A4.212, 175, 178

A-888492M91 Tube Assembly, Filter to Pump 0.30 Lbs.



For Models: 165 UK W/ A4.212, 175, 178

A-888487M91 Tube Assembly, Fuel System 0.20 Lbs.



For Models: 165 UK SN: < 116353, A4.212, 175, 178

A-888760M91 Tube Assembly, Fuel System 0.20 Lbs.



For Models: 165 UK SN: 100001 - 107086, A4.212

A-3700354M91 Tube Assembly, Fuel Filter 0.20 Lbs.
Replaces: 25358M93



For Models: 240 SN: A20286 >, W/ ERGONOMIC PEDALS, 240 SN: N01001 - A20286, W/ ERGONOMIC PEDALS, 253, 263, 360 ENG SN: < A01128

A-3700355M91 Tube Assembly, Fuel Filter 0.10 Lbs.
Dim/Info: 25359M93

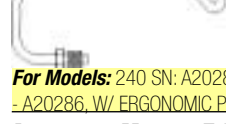

For Models: 240 SN: A20286 >, W/ ERGONOMIC PEDALS, 240 SN: N01001 - A20286, W/ ERGONOMIC PEDALS, 253, 263, 360

A-3700357M91 Tube Assembly, Fuel Filter 0.10 Lbs.
Replaces: 25361M92

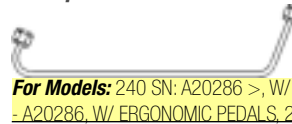

For Models: 240 SN: A20286 >, W/ ERGONOMIC PEDALS, 240 SN: N01001 - A20286, W/ ERGONOMIC PEDALS, 253, 263, 360

A-3700435M91 Tube Assembly, Tank to Pump 0.18 Lbs.
Replaces: 1873172M93, 1873172M94



For Models: 261, 265S W/ A4.236 OR A4.248, 270 EARLY PRODUCTION, 290 SN: < 2714390331, 24, 25 W/ A4.236, 50E, 50E POWER SHUTTLE, 50F, 50H, 50H SERIES S W/O TURBO CHARGER, 50HX, 50HX SERIES S W/O TURBO CHARGER, 60H, 60H SERIES S W/O TURBO CHARGER, 6500H, 6800H

A-1679407M91 Tube Assembly, Fuel System 0.10 Lbs.



For Models: 265S W/ A4.236 OR A4.248, 270 SN: < 2986287225, 290 SN: < 2714390331

A-1667052M93 Tube Assembly, Fuel Line 0.10 Lbs.
Replaces: 1667052M92



For Models: (270, 290 ALL EARLY PRODUCTION), 50E









A-194287M1 Cable, Choke 0.20 Lbs.
Dim/Info: 27 1/4" Total Length









For Models: 135 W/ CONTINENTAL MOTOR

- ALLIS CHALMERS
- CASE-IH
- CATERPILLAR
- CLARK
- DEUTZ
- FIAT
- FORD / NEW HOLLAND
- GEHL
- HYSTER
- IMT
- INGERSOLL RAND
- JACOBSEN
- JCB
- JOHN DEERE
- LANDINI
- LEYLAND
- LINCOLN ELECTRIC
- MASSEY FERGUSON
- MELROE
- MICHIGAN
- OWATTONA
- PERKINS USA
- RENAULT
- SULAIR CORP
- VERMEER
- WHITE/ OLIVER
- ZETOR

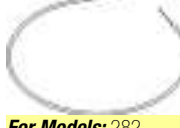

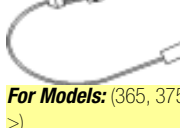
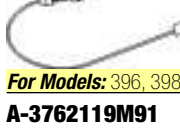
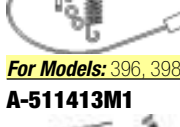
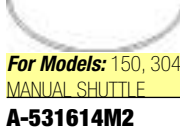



Engine Related Parts

ALLIS CHALMERS	A-519976M1	Cable, Choke	0.28 Lbs.	<i>Dim/Info:</i> 30 1/2" Total Length	
CASE-IH					
CATERPILLAR	<i>For Models:</i> 135 PERKINS GAS				
CLARK	A-505759M1	Cable, Choke	0.30 Lbs.	<i>Dim/Info:</i> 41" Total Length	
DEUTZ					
FIAT	<i>For Models:</i> 150, 165, 175, 180, 255				
FORD / NEW HOLLAND	A-544384M91	Cable, Choke	0.20 Lbs.	<i>Dim/Info:</i> 35 3/4" TOTAL LENGTH	
GEHL	<i>For Models:</i> 235, 230 S/N <-9A260658				
HYSTER	A-505758M1	Cable, Choke	0.30 Lbs.	<i>Dim/Info:</i> 36 1/2" Total Length	
IMT					
INGERSOLL RAND	<i>For Models:</i> 265 S/N <-9A349238, 150 W/ CONTINENTAL MOTOR, 255 W/ LATE PRODUCTION PERKINS GAS				
JACOBSEN	A-3759026M91	Cable, Foot Throttle	0.34 Lbs.	<i>Dim/Info:</i> 47 1/2" Total Length	
JCB					
JOHN DEERE	<i>For Models:</i> 240, 241, 243, 253, 263, 362				
LANDINI	A-3759024M91	Cable, Foot Throttle	0.29 Lbs.	<i>Dim/Info:</i> 38 1/2" Total Length	
LEYLAND					
LINCOLN ELECTRIC	<i>For Models:</i> 360, 365, 375, 383, 390, 390T, 393, 396, 398, 399				
MASSEY FERGUSON	A-3759025M91	Cable, Foot Throttle	0.32 Lbs.	<i>Dim/Info:</i> 42" Total Length	
MELROE					
MICHIGAN	<i>For Models:</i> 396, 399, (362, 398 ALL ENGINE S/N B24039->)				
OWATTONA	A-3759020M92	Cable, Hand Throttle	0.21 Lbs.	<i>Dim/Info:</i> 29 3/4" Total Length	
PERKINS USA	<i>For Models:</i> 240, 241, 243, 253, 263				
RENAULT	A-3759022M91	Cable, Hand Throttle	0.31 Lbs.	<i>Dim/Info:</i> 44 3/4" Total Length	
SULAIR CORP					
VERMEER	<i>For Models:</i> 360, 362				
WHITE/OLIVER					
ZETOR					



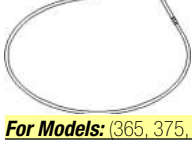
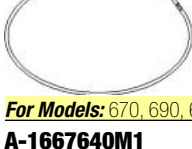
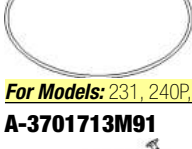

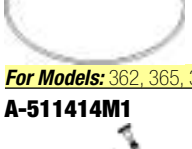

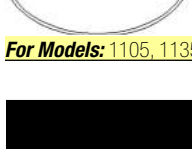
A-3759021M91	Cable, Hand Throttle	0.26 Lbs.	<i>Dim/Info:</i> 44 3/4" Total Length	
<i>For Models:</i> 360, 362, 365, 375, 383, 390, 390T, 393, 398				
A-3759023M91	Cable, Hand Throttle	0.34 Lbs.	<i>Dim/Info:</i> 53 1/4" Total Length	
<i>For Models:</i> 365, 375, 383, 390, 390T, 393, 396, 398, 399				
A-3182402M1	Cable, Throttle	0.03 Lbs.	<i>Dim/Info:</i> 44" Total Length	
<i>For Models:</i> 282				
A-1696818M94	Cable, Throttle	0.05 Lbs.	<i>Dim/Info:</i> 8" Total Length	
<i>For Models:</i> 360				
A-3761359M91	Cable, Throttle	0.12 Lbs.	<i>Dim/Info:</i> 9 1/2" Total Length	
<i>For Models:</i> (365, 375, 383, 390, 390T, 393, 398, 399 ALL ENGINE S/N C10425->)				
A-3761361M91	Cable, Throttle	0.09 Lbs.	<i>Dim/Info:</i> 17" Total Length	
<i>For Models:</i> 396, 398, 399				
A-3762119M91	Cable, Throttle	0.10 Lbs.	<i>Dim/Info:</i> 16 5/8" Total Length	
<i>For Models:</i> 396, 398, 399				
A-511413M1	Cable, Fuel Stop/ Shutoff	0.20 Lbs.	<i>Dim/Info:</i> 43" Total Length	
<i>For Models:</i> 150, 304 S/N 9A11490-> HYDRAULIC SHUTTLE, 302 S/N 9A11490-> MANUAL SHUTTLE				
A-531614M2	Cable, Fuel Stop/ Shutoff	0.05 Lbs.	<i>Dim/Info:</i> 48 1/2" Total Length	
<i>For Models:</i> 235, 230 S/N <-9A260638				

Parts are not original equipment parts and are not sponsored, affiliated, or otherwise connected with any major brand.

Parts are not original equipment parts and are not sponsored, affiliated, or otherwise connected with any major brand.

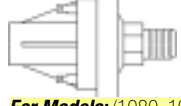

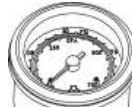

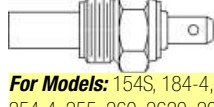



A-3701712M91	Cable, Fuel Stop/ Shutoff	0.40 Lbs.
	Dim/Info: 44 1/2" Total Length	
For Models: 240		
A-3038070M1	Cable, Fuel Stop/ Shutoff	0.40 Lbs.
	Dim/Info: 51" Total Length	
For Models: 285, 2805 S/N <-9R0374		
A-3760010M93	Cable, Fuel Stop/ Shutoff	0.50 Lbs.
	Dim/Info: 103" Total Length	
For Models: (365, 375, 390, 390T ALL S/N <-B18008)		
A-1670157M1	Cable, Fuel Stop/ Shutoff	0.40 Lbs.
	Dim/Info: 44 3/4" Total Length	
For Models: 670, 690, 698, 699		
A-1667640M1	Cable, Fuel Stop/ Shutoff	0.28 Lbs.
	Dim/Info: 38 3/4" Total Length	
For Models: 231, 240P, 261, 690, 699		
A-3701713M91	Cable, Fuel Stop/ Shutoff	0.45 Lbs.
	Dim/Info: 50 1/2" Total Length	
For Models: 360, 362, 365, 383, 390, 390T, 393, 398		
A-3701714M91	Cable, Fuel Stop/ Shutoff	0.50 Lbs.
	Dim/Info: 56" Total Length	
For Models: 362, 365, 375, 383, 390, 390T, 393, 398		
A-511414M1	Cable, Fuel Stop/ Shutoff	0.20 Lbs.
	Dim/Info: 47" Total Length	
For Models: 1080, 1085, 165, 175, 255, 265, 275		
A-528746M1	Cable, Fuel Stop/ Shutoff	0.40 Lbs.
	Dim/Info: 51 1/2" Total Length	
For Models: 1105, 1135, 285 S/N <-9A260541		









Engine Related Parts

A-509003M91	Rod, Fuel Stop/Shutoff	0.15 Lbs.
	For Models: 135, 2135	
A-3762118M91	Cable, Throttle	0.06 Lbs.
	For Models: 365, 375, 383, 390, 390T, 393, 398, 399 W/ 1006.6 Eng.	
A-273541M1	Switch, Oil Pressure Sender	0.15 Lbs.
	Replaces: 509682M1	
A-9A580	Gauge, Oil Pressure (80 lb)	0.30 Lbs.
	Dim/Info: 2" Body Dia.	
For Models: FITS SEVERAL MODELS		
A-528415M91	Gauge, Oil Pressure	0.38 Lbs.
	Replaces: White: 10A7986, 30-3485471, T016161, JT854, 10A7986, 158584A, 159565A, H344; MF: 504687M92	
For Models: (135, 165 ALL SN 9A146750>), 150, 175, 180, 1080, 1100, 1130, 1150, 31		
A-506902M1	Gauge, Oil Pressure	0.30 Lbs.
	Dim/Info: 50 lb 2" Body Dia.	
For Models: SUPER 90, T035, 202, 204, 35, 50, 65		
A-1853097M91	Gauge, Oil Pressure	0.43 Lbs.
	For Models: FE35, TEA20, 135, 148, 165, 168, 175, 178, 185, 188, 35, 65, 765, T035 W/STD. DIESEL ENG.	
A-1877731M1	Switch, Water Temp Sender	0.10 Lbs.
	Replaces: 1877731M92	
For Models: 154S, 184-4, 20D, 20F, 230, 235, 24, 240, 245, 25, 250, 253, 254, 254-4, 255, 260, 2620, 2625, 2640, 2645, 265, 2675, 2680, 2685, 2705, 2720, 2725, 274-4, 2745, 275, 2775, 2805, 283, 285, 290, 294-4, 298, 3050, 3060, 3065, 3070, 3075, 3080, 3085, 3090, 3095, 30E, 30H, 3115, 3120, 3120T, 3125, 3140, 340, 342, 350, 350S, 352, 352S, 354S, 355, 360, 362, 3630, 3635, 3645, 365, 3650, 3655, 3660, 372, 375, 382, 383, 390, 390T, 393, 398, 399, 40E, 4225, 4235, 4245, 4255, 4260, 4265, 4270, 4800, 50E, 50		

ALLIS CHALMERS
CASE-IH
CATERPILLAR
CLARK
DEUTZ
FIAT
FORD / NEW HOLLAND
GEHL
HYSTER
IMT
INGERSOLL RAND
JACOBSEN
JCB
JOHN DEERE
LANDINI
LEYLAND
LINCOLN ELECTRIC
MASSEY FERGUSON
MELROE
MICHIGAN
OWATTONA
PERKINS USA
RENAULT
SULAIR CORP
VERMEER
WHITE/ OLIVER
ZETOR

Engine Related Parts

ALLIS CHALMERS	A-303485587	Gauge, Temperature	0.58 Lbs.
	<i>Replaces:</i> 180727M91, 1078125M91, 1850512M94, 881396M91, 899455M91, 10A2229, T017273, 15A9741, 10A21284, 100679A		
CASE-IH		Dim/Info: 60" Capillary Tube w/ 5/8" UNF Connector 2" Body Dia.	
CATERPILLAR	<i>For Models:</i> 165 South Africa, 20, 202, 203, 2135, 2200, 30, 31, 3165, 35 South Africa, 35 GOVT., 35 TURF, 35 UTILITY, 40, (50, 85, 88, TQ35 ALL, South Africa)		
CLARK	A-1877719M92	Gauge, Temperature	0.16 Lbs.
DEUTZ		Dim/Info: 12 Volt Electrical 2" Dia.	
FIAT	<i>For Models:</i> 230, 231, 240, 250, 253, 265, 270, 275, 282, 283, 285, 290, 298, 550, 565, 575, 590, (2775, 2805 ALL, SN<9B0726)		
FORD / NEW HOLLAND	A-50A11	Gauge, Temperature	0.25 Lbs.
GEHL		Dim/Info: 2" Dia. 34" Capillary Tube Length 1/2" NPT Connector	
HYSTER	<i>For Models:</i> FITS SEVERAL MODELS		
IMT	A-50A25	Gauge, Temperature (100-280°)	0.25 Lbs.
INGERSOLL RAND		Dim/Info: 2" Dia. Gauge 72" Long Capillary Tube w/ 1/2" NPT Connector	
JACOBSEN	<i>For Models:</i> FITS SEVERAL MODELS		
JCB	A-180107M91	Gauge, Ammeter	0.14 Lbs.
JOHN DEERE			
LANDINI	<i>For Models:</i> 35, 35 GOVT., 35 TURF, 35 UTILITY, 50, 65, 85, 88, SUPER 90, TQ35		
LEYLAND	A-1073455M1	Gauge, Ammeter (30-0-30)	0.17 Lbs.
LINCOLN ELECTRIC		Dim/Info: 2" Dia.	
MASSEY FERGUSON	<i>For Models:</i> SUPER 90, TQ35, 165, 35, 50, 65, 85, 88		
MELROE	A-50A60	Gauge, Ammeter (60-0-60)	0.17 Lbs.
MICHIGAN		Dim/Info: 2" Body Dia. 12 Volt	
OWATTONA	<i>For Models:</i> FITS SEVERAL MODELS		
PERKINS USA	A-1672835M2	Gauge, Ammeter	0.40 Lbs.
RENAULT			
SULAIR CORP	<i>For Models:</i> 20E, 20F, 240 S/N A20286 >, 240 S/N N01001-A20286, 253, 263, 30E POWER SHUTTLE, 40E		
VERMEER			
WHITE/OLIVER			
ZETOR			

A-894844M1	Gauge, Fuel	0.42 Lbs.
For models w/ positive ground		
	Dim/Info: 2" Body Dia.	
<i>For Models:</i> 135, 148, 165, 168, 175, 178, 185, 188		
A-1877717M92	Gauge, Fuel	0.40 Lbs.
	Dim/Info: 2" Body Dia.	
<i>For Models:</i> 20D, 20F, 230, 235, 240, 245, 250, 253, 255, 260, 265, 275, 285, 290, 298, 30E, 40E, 50B, 50D, 50E, 50F, 550, 565, 575, 590, 595, (2620, 2640, 2680 ALL, SN<271212), 50 SN875001>		
A-829223M92	Tractormeter (KPH)	0.25 Lbs.
	Dim/Info: KPH Reading	
<i>For Models:</i> 35		
A-1850093M93	Tractormeter (MPH)	1.05 Lbs.
	Dim/Info: MPH Reading	
<i>For Models:</i> (35, 35X ALL W/ 23C DSL; 87MM PET, V.O./L.O. ENG.; DELUXE; SN: < 307657), TQ35 W/ STANDARD MOTORS, DSL		
A-894429M91	Tachometer (KPH)	1.05 Lbs.
Used on deluxe models.		
	Dim/Info: KPH Reading	
<i>For Models:</i> (35, 35X ALL SN: 307657 >, W/ A3.152)		
A-899423M91	Tachometer (KPH)	1.00 Lbs.
	Dim/Info: KPH Reading	
<i>For Models:</i> 135 W/ SINGLE CLUTCH ONLY		
A-899663M91	Tachometer (KPH)	0.73 Lbs.
	Dim/Info: KPH Reading	
<i>For Models:</i> (165 UK, 168, 185, 188 ALL W/ Multi-Power Transmission), (175 UK, 178 ALL W/ Standard Transmission)		
A-898489M91	Tachometer (MPH)	1.00 Lbs.
	Dim/Info: MPH Reading	
<i>For Models:</i> 165 UK W/ A4.212 OR AD4.203, MULTI POWER TRANS, (175 UK, 178 ALL W/ MULTI POWER TRANS)		

Parts are not original equipment parts and are not sponsored, affiliated, or otherwise connected with any major brand.

Engine Related Parts







Parts are not original equipment parts and are not sponsored, affiliated, or otherwise connected with any major brand.







	A-899421M91 Tachometer (KPH)	<i>Dim/Info:</i> KPH Reading	1.00 Lbs.
<i>For Models:</i> 165 UK W/ A4.212 OR AD4.203, STANDARD TRANS, (175 UK, 178 ALL W/ STANDARD TRANS)			
	A-1860063M91 Tachometer (MPH)	<i>Dim/Info:</i> MPH Reading	1.00 Lbs.
<i>For Models:</i> (165, 175, 178, 180 ALL W/8 SPEED TRANS.)			
	A-1850092M93 Tractormeter (KPH)	<i>Dim/Info:</i> KPH Reading	1.04 Lbs.
<i>For Models:</i> FE35			
	A-890223M92 Tachometer (KPH)	<i>Dim/Info:</i> KPH Reading	1.05 Lbs.
<i>For Models:</i> FE35			
	A-828031M92 Tachometer (MPH)	<i>Dim/Info:</i> MPH Reading	0.72 Lbs.
<i>Replaces:</i> 890458M95, 890458M91			
<i>For Models:</i> (65, 765 ALL SN <571856)			
	A-890421M92 Tachometer (MPH)	<i>Dim/Info:</i> MPH Reading	1.02 Lbs.
<i>Replaces:</i> 829222M92, 890222M92			
<i>For Models:</i> FE35, 35X			
	A-898485M91 Tachometer (MPH)	<i>Dim/Info:</i> MPH Reading	1.00 Lbs.
<i>Replaces:</i> 898487M92			
<i>For Models:</i> (165 UK, 175 UK, 178 ALL W/ Standard Transmission), (168, 185, 188 ALL W/ 6 Speed Gearbox)			
	A-3381904M1 Tachometer		1.00 Lbs.
<i>For Models:</i> (133, 135, 140, 145, 148, 152 ALL FRENCH)			

	A-898465M91 Tachometer (MPH)	<i>Dim/Info:</i> MPH Reading	0.72 Lbs.
<i>Replaces:</i> 898467M92			
<i>For Models:</i> 135 UK MODEL W/ DUAL CLUTCH & A3.152 DIESEL ENGINE			
	A-1674638M92 Tachometer		1.03 Lbs.
<i>Replaces:</i> 1877718M92, 1674638M91			
<i>For Models:</i> 230, 240, 550			
	A-1423769M91 Cable, Tachometer	<i>Dim/Info:</i> 53 3/4" Total Length	1.00 Lbs.
<i>For Models:</i> 154-4, 184-4, 234C, 254-4, 254-4S, 274, 274-4, 294-4			
	A-827855V1 Cable, Tachometer	<i>Dim/Info:</i> 54 1/4" TOTAL LENGTH	0.56 Lbs.
<i>For Models:</i> (35, 35X ALL FRENCH), TO35 STANDARD MOTORS DIESEL			
	A-1667951M91 Cable, Tachometer	<i>Dim/Info:</i> 23 1/2" Total Length	0.04 Lbs.
<i>For Models:</i> 235, 245, 255			
	A-506334M91 Cable, Tachometer	<i>Dim/Info:</i> 29" Total Length	0.30 Lbs.
<i>For Models:</i> 65 DIESEL			
	A-506331M91 Cable, Tachometer	<i>Dim/Info:</i> 39" Total Length	0.57 Lbs.
<i>For Models:</i> 175, 202, 204, 30 INDUSTRIAL W/ GAS ENGINE, 35 UTILITY & TURF W/ GAS ENGINE, (135, 150, 3165 ALL W/ CONTINENTAL GAS ENGINE), (165, 2135, 50 ALL W/ GAS ENGINE), TO35 W/ GAS ENGINE SN 204181>			
	A-506332M91 Cable, Tachometer	<i>Dim/Info:</i> 43 1/2" Total Length	0.30 Lbs.
<i>For Models:</i> 180 CONTINENTAL GAS & LP ENG. S/N <-645003159, 65 GAS & LP			

- ALLIS CHALMERS
- CASE-IH
- CATERPILLAR
- CLARK
- DEUTZ
- FIAT
- FORD / NEW HOLLAND
- GEHL
- HYSTER
- IMT
- INGERSOLL RAND
- JACOBSEN
- JCB
- JOHN DEERE
- LANDINI
- LEYLAND
- LINCOLN ELECTRIC
- MASSEY FERGUSON
- MELROE
- MICHIGAN
- OWATTONA
- PERKINS USA
- RENAULT
- SULAIR CORP
- VERMEER
- WHITE/ OLIVER
- ZETOR

Engine Related Parts

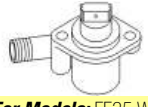
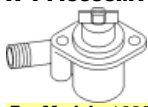
ALLIS CHALMERS	A-506335M91	Cable, Tachometer	0.40 Lbs.
CASE-IH		<i>Dim/Info:</i> 27" Total Length	
CATERPILLAR	<i>For Models:</i> 150, (30, 31 ALL INDUSTRIAL), (235, 245 ALL ORCHARD W/ DIESEL ENGINE), 203 SN <659000971, 205 SN <659100580, (165, 50 ALL W/ DIESEL ENGINE), 35 W/ DIESEL ENGINE SN <227941		
CLARK	A-513044M91	Cable, Tachometer	1.00 Lbs.
DEUTZ	Perkins Diesel S/N 645003160 - 9A48740	<i>Dim/Info:</i> 44 1/4" Total Length	
FIAT			
FORD / NEW HOLLAND	<i>For Models:</i> 230, 245, 180 PERKINS GAS, CONTINENTAL GAS S/N 645003160->, PERKINS DIESEL		
GEHL	A-579627M91	Cable, Tachometer	0.30 Lbs.
HYSTER		<i>Dim/Info:</i> 27" Total Length	
IMT	<i>For Models:</i> 245 ORCHARD DIESEL S/N 9A294105 - 9A349238		
INGERSOLL RAND	A-508231M91	Cable, Tachometer	0.39 Lbs.
JACOBSEN		<i>Dim/Info:</i> 23" Total Length	
JCB	<i>For Models:</i> 2135, 40B, 245 DIESEL EXCEPT ORCHARD, 20 INDUSTRIAL, 20C TURF W/ DIESEL ENGINE SN <9A349236, 255 W/ A4-203 DIESEL ENGINE, 230 W/ DIESEL ENGINE SN <9A349238, 135 W/ PERKINS GAS & DIESEL ENGINES		
JOHN DEERE	A-532426M92	Cable, Tachometer	0.30 Lbs.
LANDINI		<i>Dim/Info:</i> 36 3/4" TOTAL LENGTH	
LEYLAND	<i>For Models:</i> 265 GAS S/N <-9A349238, 255 PERKINS GAS		
LINCOLN ELECTRIC	A-532430M91	Cable, Tachometer	0.30 Lbs.
MASSEY FERGUSON		<i>Dim/Info:</i> 51 3/8" Total Length	
MELROE	<i>For Models:</i> 275		
MICHIGAN	A-544198M91	Cable, Tachometer	0.76 Lbs.
OWATTONA		<i>Dim/Info:</i> 53" Long	
PERKINS USA	<i>For Models:</i> (85, 88 ALL W/ DIESEL ENGINE), 255 EARLY PRODUCTION W/ A4-236 DIESEL ENGINE, 265 W/ DIESEL ENGINE SN <9A349238, 275, 285 SN <9A349238, 50C INDUSTRIAL, (SKIDDER: 320)		
RENAULT	A-1699381M92	Cable, Tachometer	0.40 Lbs.
SULAIR CORP	Replaces: 882539M1	<i>Dim/Info:</i> 27 3/32" Total Length 7/8" UNF Drive End 5/8" UNF Load End	
VERMEER	<i>For Models:</i> 135, 230, 240, 250, 35, 550, 590 OMIT CABLE ADAPTOR IF FITTED ANGLE DRIVE END IS 1/2" UNF, 135 UK MODELS ONLY, 135 W/ A3.152 PERKINS ENGINE, 20B, 20D, 20E, 20F, 30E, 35 SN <307656 W/ A3.152 PERKINS ENGINE, 35 W/A3.152 ENG. SN<307657>, 40 INDUSTRIAL W/ A3.152 PERKINS ENGINE, 65, 765		
WHITE/ OLIVER			
ZETOR			

A-3698778M94	Cable, Tachometer	0.70 Lbs.
	<i>Dim/Info:</i> 53 1/4" Total Length	
<i>For Models:</i> 365, 375, 383, 390, 390T, 393, 398		
A-1876289M93	Cable, Tachometer	0.56 Lbs.
Replaces: 876289M92, 827855M1, 882021M91, 960941M1	<i>Dim/Info:</i> 53 5/32" Total Length	
		
<i>For Models:</i> 1080, 165, 168, 175, 178, 180, 185, 188, 270, 282, 290, 30D, 50E, 375E, 50 INDUSTRIAL, (275, 283, 285, 298, 565, 575, 590 ALL OMIT CABLE ADAPTER IF FITTED ANGLE DRIVE END 1/2" UNF), 265 OMIT CABLE ADAPTOR IF FITTED ANGLE DRIVE END IS 1/2" UNF, FE35 SN <307656 W/ 23C ENGINE		
A-3302472M91	Cable, Tachometer	0.75 Lbs.
	<i>Dim/Info:</i> 27" Total Length	
<i>For Models:</i> 675, 690, 698, 698T, 699		
A-3039521M91	Cable, Tachometer	1.00 Lbs.
	<i>Dim/Info:</i> 83 3/4" Total Length	
<i>For Models:</i> 2620, 2625, 2640, 2645, 2680, 2685, 2720, 2725, 3505, 3525, 3545		
A-522879M95	Cable, Tachometer	0.10 Lbs.
	<i>Dim/Info:</i> 66 1/2" Total Length	
<i>For Models:</i> 2745, 2775, 2805, 1080 W/ A/C, 285 W/ CAB S/N <-9A349238		
A-829489M1	Gearbox, Tachometer Cable	1.25 Lbs.
	<i>Dim/Info:</i> Cable End 1/2" UNF Thread	
<i>For Models:</i> FE35 W/ 23C ENGINE		
A-1446059M1	Gearbox, Tachometer Cable	0.46 Lbs.
	<i>Dim/Info:</i> Cable End 1/2" UNF Thread	
<i>For Models:</i> 1080, 165, 168, 175, 178, 185, 188, 265, 290, 298, 565, 575, 590, 595, 675, 690, 698, 698T, 699		
A-1696816M97	Cable, Throttle	0.22 Lbs.
	<i>Dim/Info:</i> 24" Total Length	
<i>For Models:</i> 399 W/ A6-354.4 ENGINE		

Parts are not original equipment parts and are not sponsored, affiliated, or otherwise connected with any major brand.

Parts are not original equipment parts and are not sponsored, affiliated, or otherwise connected with any major brand.

A-528418M92 Gauge, Ammeter 0.40 Lbs.
Replaces: White: 10A8171, 30-3485560, 158583A, BE455A; MF: 504677M91



For Models: 135 SN 9A146750>, 150, 165 SN 9A146750>, 175, 180, 1080, 1100, 1130, 1150, 31

A-1674637M91 Tachometer 1.00 Lbs.
Replaces: 1875187M92



For Models: 265S, 275 UK MODELS, 290, 298, 565, 575, 590, 595

A-3638631M91 Pump, Oil 4.68 Lbs.
Replaces: 41314054, 3637470M91

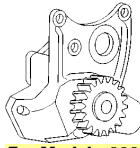

Dim/Info:
 For Non Agricultural Use

For Models: 300, 470, (255, 275 ALL E-SN <UA103063L), (50C, 6000 ALL E-SN <UA1030631), (60, 50B ALL E-SN <UA187117L), 910 ENG, 165 UK W/ 4.212 ENGINE

A-740598M1 Gear, Oil Pump 0.31 Lbs.
Replaces: 31163381



For Models: 30H

A-733551M92 Gear, Oil Pump Idler 0.50 Lbs.
Replaces: 41115025

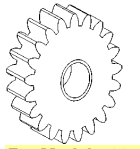

For Models: 135, 150, 154-4, 20, 20C, 20D, 20F, 200 SERIES, 202, 203, 205, 2135, 2244, 230, 235, 240, 245, 250, 2500, 30B, 30D, 30E, 30H, 35, 40, 4500, 4830FC, 50, 5830, 6030FC, 8530FC

A-736510M1 Plunger, Oil Pump 0.05 Lbs.
Replaces: 32712715



For Models: 35, 50, 65, 130, 135, 150, 165, 175, 180, 184-4, 230, 235, 240, 245, 250, 253, 254-4, 255, 265, 270, 274-4, 275, 283, 285, 290, 293, 294-4, 350, 360, 670, 690, 698, 1080, 1085, 154-4S, 1745, 4830FC, 5500, 5830FC, 5860, 5870, 6030FC, 6070, 6830, 7830, 8500, 8530, 8830, 910 ENG, 11, 20, 24, 25, 30, 20C, 20D, 20E, 30B, 30D, 30E, 30H, 31, 40, 40B, 40E, 50A, 50C, 50D, 50E, 50H, 60, 60H, 202, 203, 205, 256, 300, 302, 304, 470, 2135, 2200, 2244, 2500, 4500, 6500, 6500H, 6800H, 7500, 220, 320

Engine Related Parts

A-BKBL67S5299 Injector 1.10 Lbs.



For Models: 245 W/ 3.152 Perkins

A-827080M1 Hose, Air Cleaner 0.02 Lbs.



For Models: FE35, T035

A-530781M2 Hose, Air Cleaner 1.10 Lbs.

Dim/Info:
 A- 2.000"
 B- 2.312"



For Models: 20C, 230, 235, 245

A-898104M1 Hose, Air Cleaner 0.54 Lbs.

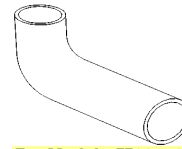

For Models: FE135, 135 UK, (155, 158, 165 ALL W/AD4.203 ENG), (35, 65, 765 ALL W/A3.152 / A4.192 /A4.203 ENG)

A-884545M1 Hose, Air Cleaner 1.64 Lbs.

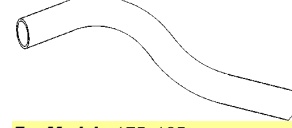

For Models: 175, 185

A-883680M1 Hose, Air Cleaner 1.80 Lbs.

Dim/Info:
 A- 2.250"



For Models: 175, 178

A-884546M1 Hose, Air Cleaner 2.08 Lbs.

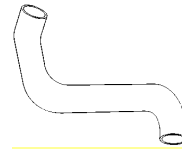

For Models:

A-1672724M1 Hose, Air Cleaner 2.00 Lbs.

Dim/Info:
 A- 2.00"



For Models: 231, 240P





A-1686294M1 Hose, Air Cleaner 1.84 Lbs.

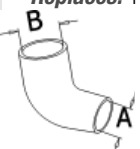
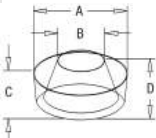

For Models: 275, 282

- ALLIS CHALMERS
- CASE-IH
- CATERPILLAR
- CLARK
- DEUTZ
- FIAT
- FORD / NEW HOLLAND
- GEHL
- HYSTER
- IMT
- INGERSOLL RAND
- JACOBSEN
- JCB
- JOHN DEERE
- LANDINI
- LEYLAND
- LINCOLN ELECTRIC
- MASSEY FERGUSON
- MELROE
- MICHIGAN
- OWATTONA
- PERKINS USA
- RENAULT
- SULAIR CORP
- VERMEER
- WHITE/ OLIVER
- ZETOR

Engine Related Parts

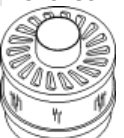
ALLIS CHALMERS	A-1876307M1	Hose, Air Cleaner <i>Replaces:</i> 1686294M1	0.59 Lbs.
CASE-IH			
CATERPILLAR			
CLARK	For Models: 261, 265S TURKEY, 275 UK, 282, 290 UK		
DEUTZ	A-101854M1	Bowl, Pre-Cleaner (10")	0.60 Lbs.
FIAT		Dim/Info: A - 10.500" B - 5.562" C - 3.000" D - 4.000"	
FORD / NEW HOLLAND	For Models: ALL MODELS		
GEHL	A-3473919M1	Bowl, Pre-Cleaner (6.375") <i>Replaces:</i> 1897117M1	0.48 Lbs.
HYSTER		Dim/Info: A - 6.375" B - 3.625" C - 2.000" D - 3.000"	
IMT	For Models: 352 <5/1994 W/ AD3.152 Engine, 372 <5/1994 W/ A4.236 Engine, 382N SN B18009> W/ A4.248 Engine, (230, 240, 250, 340, 342, 350 ALL W/ AD3.152 Engine), (355, 360 ALL W/ AT3.152.4 Engine), (265, 275, 362 ALL W/ A4.236 Engine), (285, 290, 382 ALL W/ A4.248 Engine), 298 W/ A4.318.2 Engine		
INGERSOLL RAND	A-PCA4500	Pre-Cleaner Assembly	5.30 Lbs.
JACOBSEN		Dim/Info: Inlet Diameter: 4.500" Bowl Diameter: 10.000"	
JCB			
JOHN DEERE	For Models: FITS SEVERAL MODELS		
LANDINI	A-3380636M1	Pre-Cleaner <i>Replaces:</i> 2708734M91	3.58 Lbs.
LEYLAND		Dim/Info: 10.433" 3.937" 5.709"	
LINCOLN ELECTRIC	For Models: 2640, 2645, 2680, 2685, 2725		
MASSEY FERGUSON	A-1693129M1	Pre-Cleaner	1.54 Lbs.
MELROE		Dim/Info: 6.89" 2.953" 4.921"	
MICHIGAN	For Models: 3050, 3060, 3065, 3070, 3075, 3080, 3085, 3090, 3095, 3115, 365, 375, 390, 390T, 398, 399, 6110, 6120, 6130, 6140, 6150, 6160, 6170 USA Models Only SN <F014037, 6180 USA Models Only SN F017009>, 698T, 699		
OWATTONA	A-3761802M1	Pre-Cleaner Assembly	2.15 Lbs.
PERKINS USA		Dim/Info: 6.89" Bowl Dia. 2.362" Inlet Dia. 3.937" Body Height	
RENAULT			
SULAIR CORP	For Models: 230, 240, 250, 265, 275, 285, 290, 298, 340, 342, 350, 352 All W/ AD3.152 Engine & <5/1994 W/ AT3.152.4 Engine, 355, 360, 362, 372, 382, 382N		
VERMEER			
WHITE/OLIVER			
ZETOR			

A-898390M1 Air Cleaner Assembly (Oil) 9.52 Lbs.



For Models: 50 INDUSTRIAL MODEL W/ AD4.203 OR A4.212 PERKINS ENGINE, 165 W/ AD4.203 OR A4.212 PERKINS ENGINE, 765 W/ AD4.203 PERKINS ENGINE, (168, 175 ALL W/ A4.236 PERKINS ENGINE), (178, 185, 188 ALL W/ A4.248 PERKINS ENGINE)



A-EX20	Centri Pre-cleaner Assembly, w/2" Inlet	1.50 Lbs.
A - 5.250"	B - 3.375"	C - 2.000"
50-100 CFM Range		
A-EX25	Centri Pre-cleaner Assembly, w/2 1/2" Inlet	2.30 Lbs.
A - 6.500"	B - 4.250"	C - 2.500"
100-200 CFM Range		
A-EX30	Centri Pre-cleaner Assembly, w/3" Inlet	3.30 Lbs.
A - 6.500"	B - 5.000"	C - 3.000"
150-275 CFM Range		
A-EX40	Centri Pre-cleaner Assembly, w/4" Inlet	4.70 Lbs.
A - 8.875"	B - 5.875"	C - 4.000"
200-400 CFM Range		
A-EX50	Centri Pre-cleaner Assembly, w/5" Inlet	7.10 Lbs.
A - 11.250"	B - 7.500"	C - 5.000"
350-700 CFM Range		
A-EX60	Centri Pre-cleaner Assembly, w/6" Inlet	9.20 Lbs.
A - 12.750"	B - 7.750"	C - 6.000"
500-950 CFM Range		
A-EX70	Centri Pre-cleaner Assembly, w/7" Inlet	0.00 Lbs.
A - 14.750"	B - 8.500"	C - 7.000"
750-1350 CFM Range		
A-EX80	Centri Pre-cleaner Assembly, w/8" Inlet	0.00 Lbs.
A - 14.750"	B - 8.500"	C - 8.000"
950-1600 CFM Range		

For Models: ALL MODELS

Parts are not original equipment parts and are not sponsored, affiliated, or otherwise connected with any major brand.

Parts are not original equipment parts and are not sponsored, affiliated, or otherwise connected with any major brand.



A-954030 Centri Rubber Hump Hose Reducer w/2 Clamps 4"-3" 1.50 Lbs.

Dim/Info:
5 1/4" Length

A-954045 Centri Rubber Hump Hose Reducer w/2 Clamps 4"-4 1/2" 1.80 Lbs.

A-955040 Centri Rubber Hump Hose Reducer w/2 Clamps 5"-4" 1.90 Lbs.

Dim/Info:
5 1/2" Length

A-955055 Centri Rubber Hump Hose Reducer w/2 Clamps 5"-5 1/2" 0.00 Lbs.

Dim/Info:
6" Length

A-956050 Centri Rubber Hump Hose Reducer w/2 Clamps 6"-5" 0.00 Lbs.

Dim/Info:
6" Length

A-956055 Centri Rubber Hump Hose Reducer w/2 Clamps 6"-5 1/2" 0.00 Lbs.

Dim/Info:
6" Length

A-957060 Centri Rubber Hump Hose Reducer w/2 Clamps 7"-6" 0.00 Lbs.

Dim/Info:
6" Length

A-958060 Centri Rubber Hump Hose Reducer w/2 Clamps 8"-6" 0.00 Lbs.

Dim/Info:
8" Length

A-958070 Centri Rubber Hump Hose Reducer w/2 Clamps 8"-7" 0.00 Lbs.

Dim/Info:
5" Length

For Models: ALL MODELS



A-94400 Centri Rubber Hump Hose w/2 Clamps 4" 1.60 Lbs.

Dim/Info:
5 1/2" Length

A-94500 Centri Rubber Hump Hose w/2 Clamps 5" 1.90 Lbs.

Dim/Info:
6" Length

A-94600 Centri Rubber Hump Hose w/2 Clamps 6" 0.00 Lbs.

Dim/Info:
7" Length

A-94700 Centri Rubber Hump Hose w/2 Clamps 7" 0.00 Lbs.

Dim/Info:
7" Length

A-94800 Centri Rubber Hump Hose w/2 Clamps 8" 0.00 Lbs.

Dim/Info:
7" Length

For Models: ALL MODELS

Engine Related Parts



A-972522 Rubber Insert Extrusion Reducer 2 1/2"-2 1/4" 0.10 Lbs.

A-973027 Rubber Insert Extrusion Reducer 3"-2 3/4" 0.10 Lbs.

A-975047 Rubber Insert Extrusion Reducer 5"-4 3/4" 0.30 Lbs.

For Models: ALL MODELS



A-974030 Rubber Extrusion Reducer 4"-3" 0.40 Lbs.

A-974035 Rubber Extrusion Reducer 4"-3 1/2" 0.30 Lbs.

A-974037 Rubber Extrusion Reducer 4"-3 3/4" 0.20 Lbs.

A-975040 Rubber Extrusion Reducer 5"-4" 0.70 Lbs.

A-975045 Rubber Extrusion Reducer 5"-4 1/2" 0.50 Lbs.

A-976050 Rubber Extrusion Reducer 6"-5" 0.70 Lbs.

For Models: ALL MODELS

A-3637326E91 Turbocharger 17.80 Lbs.
Replaces: 3637326M91



For Models: (390T, 393, 398 ALL W/ AT4.236 Eng.)

A-1447152M91 Turbocharger 16.28 Lbs.
Replaces: 1446954M91



For Models: 1105, 1135 Eng. SN 354UA16470T->

A-1853324M91 Turbocharger 19.08 Lbs.
Turbo model 3LD4/1.6
Replaces: 2674216



For Models: 1130 Eng. SN 354UA1181T->, 1135 Eng. SN <-354UA16469T



A-1447769E91 Turbocharger 17.80 Lbs.
Replaces: 2674A104, 1447769M91



For Models: (25, 3065, 3070 ALL W/ AT4.236 Eng.)

- ALLIS CHALMERS
- CASE-IH
- CATERPILLAR
- CLARK
- DEUTZ
- FIAT
- FORD / NEW HOLLAND
- GEHL
- HYSTER
- IMT
- INGERSOLL RAND
- JACOBSEN
- JCB
- JOHN DEERE
- LANDINI
- LEYLAND
- LINCOLN ELECTRIC
- MASSEY FERGUSON
- MELROE
- MICHIGAN
- OWATTONA
- PERKINS USA
- RENAULT
- SULAIR CORP
- VERMEER
- WHITE/ OLIVER
- ZETOR

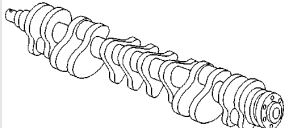
Engine Related Parts

ALLIS CHALMERS	A-3637408M91	Crankshaft, Keyed Nose, Lip Seal	102.00 Lbs.	
CASE-IH				
CATERPILLAR				
CLARK	For Models: (550, TX550 ALL 6.354.4 DSL), (750, 760 ALL T6.354.1/TC6.354.1 DSL)			
DEUTZ	A-738588M1	Gear, Ring	4.50 Lbs.	
FIAT		<i>Replaces:</i> 730407, 31162121		
FORD / NEW HOLLAND		<i>Dim/Info:</i> 126 Teeth		
				
	For Models: (COMBINE: 8450), (SWATHER: 885)			
GEHL	A-520948M91	Cap, Fuel	0.16 Lbs.	
HYSTER				
IMT	For Models: 300, 410, 510, 540, 550, 750, 760, 850, 855, 860, 865			
INGERSOLL RAND				
JACOBSEN				
JCB				
JOHN DEERE				
LANDINI				
LEYLAND				
LINCOLN ELECTRIC				
MASSEY FERGUSON				
MELROE				
MICHIGAN				
OWATTONA				
PERKINS USA				
RENAULT				
SULAIR CORP				
VERMEER				
WHITE/OLIVER				
ZETOR				

Parts are not original equipment parts and are not sponsored, affiliated, or otherwise connected with any major brand.