

Hitch & Drawbar Parts

Parts are not original equipment parts and are not sponsored, affiliated, or otherwise connected with any major brand.

AGCO
ALLIS
CHALMERS
DEUTZ
MASSEY
FERGUSON
WHITE/
OLIVER

A-534934R92 PTO Clutch Kit 1.64 Lbs.

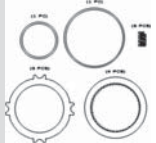

A-401715R1 Spring, PTO Clutch 0.01 Lbs.
A-401716R2 Disc, PTO Clutch 0.16 Lbs.
A-401717R1 Plate, PTO Clutch 0.20 Lbs.
A-401723R1 O-ring, PTO Clutch 0.02 Lbs.
A-401724R1 O-ring, PTO Clutch 0.02 Lbs.

For Models: (2400, 454, 574 ALL W/ SN<100000)

A-66193C91 PTO Clutch Kit 2.10 Lbs.

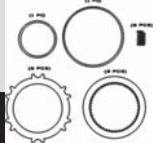

A-66182C1 Spring, PTO Clutch 0.02 Lbs.
A-401716R2 Disc, PTO Clutch 0.16 Lbs.
A-66188C1 Plate, PTO Clutch 0.16 Lbs.
A-401723R1 O-ring, PTO Clutch 0.02 Lbs.
A-401724R1 O-ring, PTO Clutch 0.02 Lbs.

For Models: H84, 385, 395, 464, 484, 485, 495, 584, 585, 595, 674, 684, 685, 695, 784, 885, (2400A, 2500A, 574 ALL W/ SN 10001->)

A-ST215 Bearing, Ball 0.80 Lbs.



BELARUS

For Models: 2424, 2444, 2544, 2656, 424, 444, 544, 656, 664, (FORAGE HARVESTER: 555, 650), 2504, 2606, 300 FARMALL, 330, 340, 350 FARMALL, 384, 400 FARMALL, 460, 504, 560, 606, 660, 666, 686, H, HV, M, MD, MDV, MV, SUPER H, SUPER HV, 450, HYDRO 86, HYDRO 70

A-308611A1 Shaft, PTO 1000 RPM 16.14 Lbs.



Dim/Info:
17 Teeth
20 Spline
17.290" Long

For Models: 7150, 7230, 7240, 7250, 8930, 8940, 8950, (7130, 7140 ALL TRANS. SNAJB0059710->)

A-338165A1 Shaft, PTO 1000 RPM 14.54 Lbs.

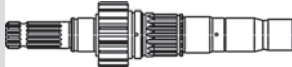

Dim/Info:
18 / 17 Teeth
21 Spline
15.220" Long

For Models: (7210, 7220, 7230, 7240, 7250, 8910, 8920, 8930, 8940, 8950 ALL W/DUAL SPEED PTO)

A-130566C1 Cable, PTO Control 1.45 Lbs.



Dim/Info:
73" Total Length

For Models: 3088, 3288, 3688, 6388, 6588, 6788, 3488 HYDRO

A-143961C1 Cable, PTO Control 1.20 Lbs.



Dim/Info:
50 1/2" Total Length

For Models: 5088, 5288, 5488

SCHWARTZ
SPEECO

A-1289125C2 Housing, Rockshaft Cylinder 52.50 Lbs.
Replaces: 1289125C1

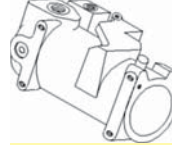

For Models: 7110, 7120, 7130, 7140, 7150, 7210, 7220, 7230, 7240, 7250, 8910, 8920, 8930, 8940, 8950

A-84923C3 Arm, Bellcrank Rockshaft 16.00 Lbs.
Replaces: 84923C2, 84923C1

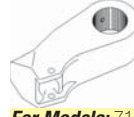

For Models: 7110, 7120, 7130, 7140, 7150, 7210, 7220, 7230, 7240, 7250, 8910, 8920, 8930, 8940, 8950

A-1331848C1 Bushing, Rockshaft (RH) 0.70 Lbs.

A-1331849C1 Bushing, Rockshaft (LH) 0.70 Lbs.



For Models: 7110, 7120, 7130, 7140, 7150, 7210, 7220, 7230, 7240, 7250, 8910, 8920, 8930, 8940, 8950

A-1266760C4 Cylinder, Hitch 19.85 Lbs.
1 3/4" Bore x 10 3/4" Stroke

Replaces: 1266760C3, 1266760C2, 1266760C1, 1266760C91



For Models: 7120, 7130, 7140, 7150, 7220, 8920, 8930, 8940, 8950

A-1994514C1 Cylinder Assembly, Hitch 27.80 Lbs.

Replaces: 1986560C1



Dim/Info:

2 1/4" Bore X 10 3/4" Stroke

For Models: 7130, 7140, 7150, 7230, 7240, 7250, 8930, 8940, 8950

A-223322 3 Point Hitch Kit (Cat II) 16.88 Lbs.
Consist of: (1) level box (not sold separately), (1) A-69993C91 screw, (1) A-402635R4 housing.



A-3069063R1 Pinion Gear 0.09 Lbs.

For Models: (584, 674, 784, 884 ALL ROW CROP), (585, 595, 685, 695, 885, 895, 995 ALL W/BAR TYPE REAR AXLE)

A-223323 3 Point Hitch Kit, (Cat II) 17.30 Lbs.
Consist of: (1) level box (not sold separately), (1) A-3116725R91 screw, (1) A-402635R4 housing.



A-3069063R1 Pinion Gear 0.09 Lbs.

For Models: (395, 495 ALL TELESCOPE LINKS), (784, 884 ALL W/ FLANGE TYPE REAR AXLE), (584, 585, 595, 685, 695, 885, 895, 995 ALL W/FLANGE TYPE REAR AXLE)

*** Truck icon indicates the item is shipped via truck freight. ***

Hitch & Drawbar Parts

Parts are not original equipment parts and are not sponsored, affiliated, or otherwise connected with any major brand.

A-223320 3 Point Hitch Kit, (RH) (Cat I) 16.24 Lbs.
Consist of: (1) level box (not sold separately), (1) A-69991C91 screw, (1) A-3121964R1 housing.



A-3069063R1 Pinion Gear 0.09 Lbs.

For Models: 454, 464, 484, 485, 495, 574, 584, 585, 595, 674, 684, 784, 884

A-223321 3 Point Hitch Kit, (RH) (Cat II) 16.56 Lbs.
Consist of: (1) level box (not sold separately), (1) A-69992C91 screw, (1) A-402635R4 housing.

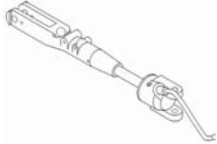

A-3069063R1 Pinion Gear 0.09 Lbs.

For Models: 454, 464, 484, 574, 584, 595, 674, 684, 784, 884, 895, 995

A-3069064R1 Bearing, Leveling Screw 1.08 Lbs.



For Models: 354, 384, 385, 395, 424, 444, 454, 464, 484, 485, 495, 574, 584, 585, 595, 674, 684, 685, 695, 784, 884, 885, 895, B414, H84, 2300, 2400, 2424, 2444, 2500

A-223317 3 Point Hitch Kit, (Cat I) 12.92 Lbs.
Consist of: (1) A-527967 lift rod, (1) A-704207R3 swivel, (1) A-3069069R1 pin, (1) A-3121964R91 housing, (1) A-527937R1 nut.



For Models: 385, 395, 454, 464, 484, 485, 495

A-223319 3 Point Hitch Kit, (Cat II) 12.86 Lbs.
Consist of: (1) A-527948 lift rod, (1) A-704207R3 swivel, (1) A-3069069R1 pin, (1) A-402635R4 housing, (1) A-527937R1 nut.



For Models: HYDRO 84 HYDRO, W/TELESCOPIC ARM, (584, 585, 595, 674, 685, 695, 785, 884 ALL W/TELESCOPIC ARM), 574 W/TELESCOPIC ARM

A-223318 3 Point Hitch Kit, (Cat I) 13.24 Lbs.
Consist of: (1) A-527948 lift rod, (1) A-704207R3 swivel, (1) A-3069069R1 pin, (1) A-3121964R91 housing, (1) A-527937R1 nut.



For Models: HYDRO 84 HYDRO, W/FIXED ARMS, (574, 585, 595, 674, 684, 685, 695, 784, 884 ALL W/FIXED ARMS)

A-704207R3 Swivel 0.93 Lbs.
Replaces: 539247R1



For Models: 2300A, 2400A, 2424, 2500A, 354, 364, 384, 444, 454, 523, 574, 584, 595, 654, 674, 684, 685, 695, 786, 824, 884, 885, 895, HYDRO 84 HYDRO, 585 W/ BAR AXLE

A-3069069R2 Pin 0.31 Lbs.

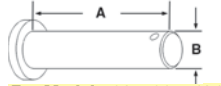

Dim/Info:
A - 3.73"
B - .622"

For Models: 385, 395, 484, 485, 584, 585, 595, 684, 685, 695, 784, 884, 885, 895, HYDRO 84 HYDRO

A-383990R2 Duckhead 2.60 Lbs.
Fits 1" Screw



For Models: HYDRO 100, HYDRO 70, HYDRO 86, 1026, 1066, 1466, 1468, 21026, 2544, 2656, 2706, 2756, 2806, 2826, 2856, 544, 656, 664, 666, 686, 706, 756, 766, 806, 826, 856, 966

A-A57496* Link, 3 Point Lower Lift 1.90 Lbs.

For Models: 730 SN 2229995>, 770, 830 SN 2229995>, 870, 930 SN 2229995>, 970

A-527967R1 Lift Yoke, (LH side) 3.16 Lbs.



Dim/Info:
14.380" Long
.875" - 9 UNC Thread

For Models: 2400, 385, 395, 454, 464, 484, 485, 495

A-527948R91 Lift Yoke, (LH Side) 3.80 Lbs.
Replaces: 527935R1



Dim/Info:
19.250" (Long)
.875" - 9 UNC (Thread)

For Models: 2500A, 574, 584, 595, 595XL, 674, 684, 685, 685XL, 695, 695XL, 784, 884, 895, 895XL, HYDRO 84 HYDRO, 585 W/FLANGE AXLE

A-223306 2 or 3 Point Hitch Kit, (RH/LH) 25.28 Lbs.
Consist of: (1) A-523861R2 handle, (1) A-223315 duckhead, (1) A-389542R11 screw, (1) A-538970 housing 16.750" long.

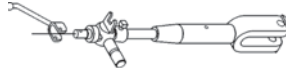

For Models: 544, 656, 666, 686, HYDRO 70, HYDRO 86

A-223305 Lift Arm For 2 Point Fast Hitch (LH) 10.30 Lbs.
Consists of: (1) A-523861R2 handle, (1) A-223316 duckhead, (1) A-523864R1 screw, (1) A-522819R1 housing. Note: Can be used on RH side if duckhead is flipped over.



For Models: 2606, 300, 330, 340, 350, 400, 460, 560, 606, 660

A-223307 2 Point Fast Hitch Kit (RH/LH) 18.60 Lbs.
Consist of: (1) A-523861R2 handle, (1) A-223315 duckhead, (1) A-389542R11 screw, (1) A-395142R1 housing 11.750" long.



For Models: 1066, 706, 756, 766, 806, 826, 966

AGCO
ALLIS
CHALMERS
DEUTZ
MASSEY
FERGUSON
WHITE/
OLIVER

CNH
CASE-IH

FORD / NEW
HOLLAND
FIAT

BELARUS

BOBCAT

JCB

JOHN
DEERE

KUBOTA

LANDINI

LEYLAND

LONG

McCORMICK

OTHER

RENAULT

SAME

VALTRA

VERSATILE

YANMAR

ZETOR

SCHWARTZ
SPEECO

*** Truck icon indicates the item is shipped via truck freight.***

Hitch & Drawbar Parts

Parts are not original equipment parts and are not sponsored, affiliated, or otherwise connected with any major brand.

A-223308 3 Point Hitch Kit (RH/LH) 19.54 Lbs.
 Consist of: (1) A-523861R2 handle, (1) A-223315 duckhead, (1) A-382165R1 screw, (1) A-395142R1 housing 11.750" long.

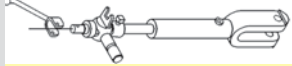

For Models: 706, 756, 766, 806, 826, 966

A-223309 3 Point Hitch Kit (LH) (Cat II) 27.32 Lbs.
 Consist of: (1) A-523861R2 handle, (1) A-397095R2 screw, (1) A-396752R1 housing 16.375" long.



For Models: HYDRO 100, 756, 766, 826, 856, 966, 1206

A-223310 3 Point Hitch Kit (RH) (Cat II) 27.54 Lbs.
 Consist of: (1) A-523861R2 handle, (1) A-397096R2 screw, (1) A-396752R1 housing 16.375" long.



For Models: HYDRO 100, 756, 766, 826, 856, 966, 1206

A-392204R1 Center Link Handle 0.80 Lbs.

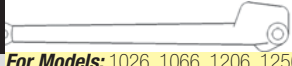

For Models: 1026, 1066, 1206, 1256, 1456, 1466, 1468, 1566, 1568, 21206, 21256, 21456, 2544, 2656, 2756, 2826, 2856, 544, 656, 664, 666, 686, 756, 766, 806, 826, 856, 966, (2504, 504 ALL FARMALL SN 15030> & INTERNATIONAL SN 16698>), 2806, HYDRO 100, HYDRO 70, HYDRO 86

A-527943R1 Handle, Lift Arm 0.60 Lbs.



For Models: 2400A, 2500A, 384, 385, 395, 454, 464, 484, 485, 495, 574, 584, 585, 595, 674, 685, 695, 884, 885

A-523861R2 Crank Handle 0.80 Lbs.



For Models:

A-223315 Duckhead Pivot Assembly, 1" Screw 3.73 Lbs.
 Includes: "duckhead", collar w/ set screws, hardened washer & weld on washer. Fits 1" Shaft.



For Models:

A-223316 Duckhead Pivot Assembly, 7/8" 3.57 Lbs.
 Fits 7/8" Screw.



For Models: 300, 330, 340, 350, 400, 460, 560, 606, 660, 2606

A-69991C91 Screw w/ Bevel Gear 2.58 Lbs.

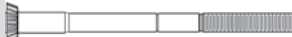

Dim/Info:
 .875" Dia.
 14.375" Long

For Models: 385, 395, 454, 464, 484, 485, 495, 248, 2400A

A-69992C91 Screw w/ Bevel Gear 2.84 Lbs.
Replaces: 527942R1

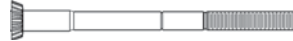

Dim/Info:
 .875" Dia.
 15.875" Long

For Models: 574, 674

A-69993C91 Screw w/ Bevel Gear 3.04 Lbs.
Replaces: 69988C1, 527939R1

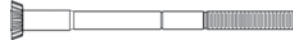

Dim/Info:
 .875" Dia.
 16.625" Long

For Models: HYDRO 84 HYDRO, ROW CROP, (574, 584, 674, 684, 784, 884 ALL ROW CROP), (685, 595, 685, 695, 885, 995 ALL W/BAR TYPE REAR AXLE)

A-3116725R91 Screw w/ Bevel Gear 3.24 Lbs.



Dim/Info:
 .875" Dia.
 18.125" Long

For Models: 584, 784, 884, 585-995 W/FLANGE TYPE REAR AXLE, (395, 495 ALL W/TELESCOPE LINK)

A-527937R1 Nut, Leveling Yoke 0.34 Lbs.
 For yoke # 3121964R1



For Models: 385-885, 395-895, 454-484, 584-884

A-69831C1 Screw, Leveling Fast Hitch 2.45 Lbs.



Dim/Info:
 .875" Dia.
 15.31" Long

For Models: A1, SUPERA, 100, 130, 140

A-523864R11 Screw, Leveling (RH/LH) 2.54 Lbs.



Dim/Info:
 .875" Dia.
 15.750" Long

For Models: 2504, 2606, 300, 330, 340, 400, 450, 460, 504, 560, 606, 660

A-389542R1 Assembly, Leveling Screw 5.38 Lbs.



Dim/Info:
 1.000" Dia.
 25.500" Long
 6.000" Thread

For Models: 544, 656, 666, 686, HYDRO 70, HYDRO 86

A-382165R11 Assembly, Leveling Screw 5.92 Lbs.



Dim/Info:
 1.000" Dia.
 27.000" Long
 5.000" Thread

For Models: 706 W/3 POINT HITCH, 806 W/3POINT HITCH

A-397095R2 Assembly, Leveling Screw (LH) 9.22 Lbs.



Dim/Info:
 1.125" Dia.
 22.500" Long

For Models: HYDRO 100, 756, 766, 826, 856, 966, 1026, 1206

A-397096R2 Assembly, Leveling Screw (RH) 9.02 Lbs.

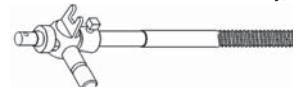

Dim/Info:
 1.125" Dia.
 22.500" Long

For Models: HYDRO 100, 756, 766, 826, 856, 966, 1206

A-398378R1 Assembly, Leveling Screw (RH/LH) 7.64 Lbs.



Dim/Info:
 1.375" Dia.
 24.750" Long

For Models: 1206, 1256, 1456, 1066 SN <48907, 1466 SN <26201, 1468

*** Truck icon indicates the item is shipped via truck freight. ***

Hitch & Drawbar Parts

Parts are not original equipment parts and are not sponsored, affiliated, or otherwise connected with any major brand.

A-108584C1 Screw, Upper Adjusting 3.34 Lbs.



Dim/Info:
1.250"-7 RH Thread
10.000" Long
5.125" Thread Length

For Models: HYDRO 186, 1066, 1086, 1466, 1468, 1486, 1566, 1586, 3088, 3288, 3388, 3488, 3588, 3688, 3788, 6388, 6788

A-149838C1 Screw, Upper Adjusting 3.76 Lbs.

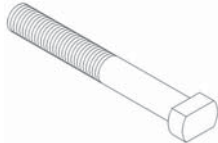

Dim/Info:
1.250"-7 RH Thread
11.500" Long
6.250" Thread Length

For Models: 5088, 5288, 5488, 7110, 7120, 7130, 7140, 7150, 7210, 7220, 7230, 7240, 7250, 8910, 8920, 8930, 8940, 8950, MX150, MX170

A-108583C1 Screw, Lower Adjusting 5.46 Lbs.

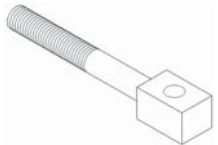

Dim/Info:
1.250"-7 LH Thread
12.000" Long
6.000" Thread Length

For Models: HYDRO 186, 1066, 1086, 1466, 1468, 1566, 1586, 3088, 3288, 3388, 3488, 3588, 3688, 3788, 6388, 6788

A-149837C1 Screw, Lower Adjusting 5.46 Lbs.
Replaces: 1272852C1, 1272852C91

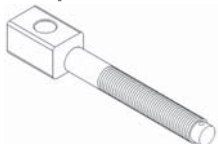

Dim/Info:
1.250"-7 LH Thread
12.125" Long
6.268" Thread Length

For Models: 5088, 5288, 5488, 7110, 7120, 7130, 7140, 7150, 7210, 7220, 7230, 7240, 7250, 7288, 7488, 8910, 8920, 8930, 8940, 8950

A-1965392C3 Turnbuckle, Lift Link 6.15 Lbs.



For Models: 5120, 5130, 5140, 5220, 5230, 5240, 5250, MX100, MX100C, MX110, MX120, MX135, MX80C, MX90C

A-520067R1 Lift Yoke 3.24 Lbs.

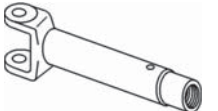

Dim/Info:
9.380" Overall Length
7/8-9 UNC RH Thread

For Models: A1, SUPER A, 100, 130, 140

A-3121964R91 Housing, Leveling Screw (Cat I) 7.30 Lbs.

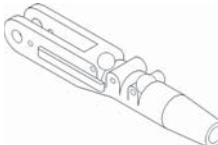

Dim/Info:
14.500" Long
For .875" Screw
1" Space in Fork

For Models: 454, 464, 484, 495, 574, 584, 595, 674, 684, 685, 784, 884

A-402635R4 Housing, Leveling Screw (Cat II) 7.50 Lbs.

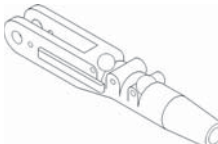

Dim/Info:
14.500" Long
For .875" Screw
1.625" Space in Fork

For Models: 454, 464, 484, 495, 574, 584, 595, 674, 684, 685, 784, 884, 885, 995

A-522819R1 Housing, Leveling Screw (RH/LH) 3.18 Lbs.

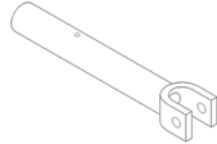

Dim/Info:
11.500" Long

For Models: 2504, 2606, 300, 330, 340, 350, 400, 450, 460, 504, 560, 606, 660

A-538970R1 Housing, Leveling Screw 11.40 Lbs.

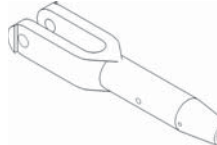

Dim/Info:
16.750" Long
For 1.000" Screw
Use w/ 389542R11 Screw

For Models: (544, 656, 664, 666, 686, HYDRO 70 ALL USED ON BOTH 2POINT & 3POINT HITCHES)

A-395142R1 Housing, Leveling Screw 6.36 Lbs.



Dim/Info:
11.750" Long
For 1.000" Screw
Use w/ 382165R11 Screw

For Models: 1066, 706, 756, 766, 806, 826, 966

A-396752R1 Housing, Leveling Screw 16.05 Lbs.
Used w/ A-397096R2 screw.

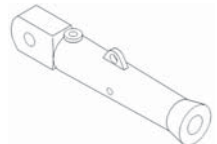

Dim/Info:
16.500" Long

For Models: HYDRO 100, 706 LATE, 756, 766, 806 LATE, 826, 856, 966, 1026, 1206

A-398384R1 Housing, Leveling Screw 15.50 Lbs.
Used w/ A-398378R1 screw.

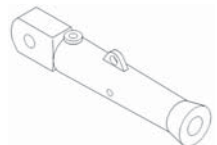

Dim/Info:
16.375" Long

For Models: HYDRO 100, 1026, 1066, 1256, 1456, 1466, 1468, 1566

A-72877C1 Housing, Leveling Screw 13.56 Lbs.
Used w/ A-108583C1 & A-108584C1 screws.

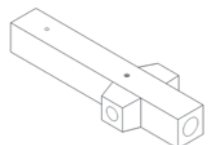

Dim/Info:
14.125" Long
1.250" Screw Thread

For Models: 1086, 1486, 1566, 1568, 1586, 3388, 3588, 3788, 6388, 6588, 6788, 786, 886, 986, HYDRO 86, HYDRO 3488

A-149836C4 Housing, Leveling Screw 13.06 Lbs.

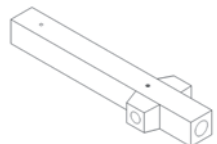

Dim/Info:
17.000" Long
1.250" Screw Thread

For Models: 5088, 5288, 5488, 7110, 7120, 7130, 7140, 7150, 7210, 7220, 7230, 7240, 7250, 8910, 8920, 8930, 8940, 8950, 9310, 9330, 9350

A-520107R1 Collar, Fast Hitch 0.54 Lbs.

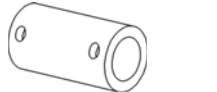

For Models: A1, SUPER A, 100, 130, 140

AGCO
ALLIS
CHALMERS
DEUTZ
MASSEY
FERGUSON
WHITE/
OLIVER

CNH
CASE-IH

FORD / NEW
HOLLAND
FIAT

BELARUS

BOBCAT

JCB

JOHN
DEERE

KUBOTA

LANDINI

LEYLAND

LONG

MCCORMICK

OTHER

RENAULT

SAME

VALTRA

VERSATILE

YANMAR

ZETOR

SCHWARTZ
SPEECO

*** Truck icon indicates the item is shipped via truck freight.***

Hitch & Drawbar Parts

Parts are not original equipment parts and are not sponsored, affiliated, or otherwise connected with any major brand.

AGCO
ALLIS
CHALMERS
DEUTZ
MASSEY
FERGUSON
WHITE/
OLIVER
CNH
CASE-IH
FORD / NEW
HOLLAND
FIAT
BELARUS
BOBCAT
JCB
JOHN
DEERE
KUBOTA
LANDINI
LEYLAND
LONG
McCORMICK
OTHER
RENAULT
SAME
VALTRA
VERSATILE
YANMAR
ZETOR

A-406685R1 Front Pin, Lower Pull Arm 0.75 Lbs.

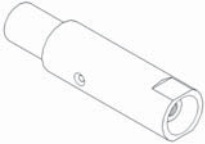

For Models: HYDRO 100, HYDRO 186, 544, 656, 706, 756, 766, 786, 826, 856, 886, 966, 986, 1026, 1066, 1086, 1466, 1468, 1468, 1486, 2544, 2656, 2706, 2756, 2826, 2856, 3088, 3288, 3488, 3688

A-406686R2 Front Pin, Lower Pull Arm 1.00 Lbs.
Replaces: 406686R1

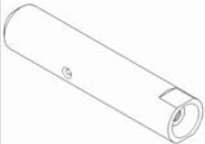

For Models: HYDRO 100, 766, 786, 886, 966, 986, 1066, 1086, 1206, 1256, 1456, 1466, 1468, 1486, 1566, 1568, 1586, 3388, 3588, 3788, 5088, 5288, 5488, 6388, 6588, 6788, 21206, 21256, 21456

A-124900A1 Pull Arm, Lower (Cat II) 20.64 Lbs.
Replaces: 1286791C91



Dim/Info:
1.375" Ball

For Models: 380B, 385, 395, 485, 495

A-LP03 Pin, Cat. I Lift; 2 Per Package 2.25 Lbs.



Dim/Info:
.875" Thread
.875" pin dia.
5.500" length

For Models: SEVERAL

A-389372R41 Bracket, Top Linkage 14.04 Lbs.



For Models: 544, 656, 666, 686, HYDRO 70, HYDRO 86

A-382212R41 Bracket, Top Linkage 23.14 Lbs.



For Models: 1206, 1256, 706, 756, 806, 856

A-1328192C3 Top Link Pin (Cat II) 1.20 Lbs.



For Models: 3210, 3220, 3230, 385, 395, 4210, 4220, 4230, 4240, 454, 474, 475, 484, 485, 495, 574, 584, 585, 595, 674, 684, 685, 695, 784, 785, 795, 884, 885, 895, 985, 995

A-1331854C2 Center Link Assembly (Cat III) 35.10 Lbs.
Assembly consist of one each of the Items listed below. Complete assy. will work for models 1066-6788. Components are not compatible for models 1066-6788. Components are compatible for models 7110-8950.
Replaces: 404632R91, 108591C91, 1252108C92



Dim/Info:
Heavy Duty
1.500" Threads on Ends

A-1954221C3 Center Link Body 12.70 Lbs.

A-1981986C1 Center Link End (Front - RH Thread) 8.32 Lbs.

A-1282063C2 Center Link End (Rear - LH Threads) 8.38 Lbs.

A-1331863C2 Center Link Handle 2.84 Lbs.

For Models: 7110, 7120, 7130, 7140, 7150, 7210, 7220, 7230, 7240, 7250, 8910, 8920, 8930, 8940, 8950, (1066, 1086, 1206, 1256, 1456, 1466, 1468, 1486, 1566, 1568, 1586, 21206, 21256, 21456, 3388, 3588, 3788, 5088, 5288, 5488, 6388, 6588, 6788 ALL MUST USE COMPLETE CENTER LINK ASSEMBLY)

A-382210R11 Center Link Pin (Tractor End) (Cat II) 1.50 Lbs.



For Models: 1026, 2544, 2656, 2756, 2806, 2826, 2856, 3088, 3288, 3488, 3688, 544, 656, 664, 666 Gear Drive SN <13995, 756, 766, 786, 806, 826, 856, 886 SN 14745>, 966, 986 SN 20146>, HYDRO 100, HYDRO 70 SN <9057

A-1286840C7 Pin Assembly 2.60 Lbs.



For Models: 1066 SN <48907, 1086 SN 36378>, 1206, 1256, 1456, 1466 SN <26201, 1468, 1486 SN 19550>, 1566 SN <11255, 1568 SN <7908, 1586 SN 16784>, 21206, 21256, 21456, 3388, 3588, 3788, 4100, 4166 SN <11779, 4186, 5088, 5288, 5488, 6388, 6588, 6788

A-108632C93 Center Link Assembly (Cat. II) 21.50 Lbs.
Assembly consists of one of each of the following items: 404633R2, 395970R2, 395968R2 & 108592C2.



A-404633R2 Center Link Body 6.90 Lbs.

A-395970R2 Center Link End (Front) 5.08 Lbs.

A-395968R2 Center Link End (Rear) 4.92 Lbs.

A-108592C2 Center Link Handle 0.09 Lbs.

For Models: HYDRO 100, HYDRO 186, 756, 766, 786, 826, 856, 886, 966, 986, 1026, 2756, 2826, 2856, 3088, 3288, 3488, 3688

A-398371R11 Lower Pull Arm Link (LH) 9.93 Lbs.

A-398372R11 Lower Pull Arm Link (RH) 9.21 Lbs.



For Models: HYDRO 100, HYDRO 186, 706 Farmall SN 37237>, International SN 5274>, 756, 766, 786, 806 Farmall SN 33163>, International SN 7101>, 826, 856, 886, 966, 986, 1026, 2706 Farmall SN 37237>, International SN 5274>, 2756, 2806 Farmall SN 33163>, International SN 7101>, 2826, 2856, 3088, 3288, 3488, 3688, 21026

A-380993R2 Latch, Lift Arm 2.20 Lbs.



For Models: H70, H86, 254, 2606, 2656, 544, 606, 656, 664, 666, 686, 2504 FARMIL SN 15030>, 2504 IH SN 16698>

A-393500R1 Latch, Lower Pull Arm 0.96 Lbs.



For Models: (100, 130, 140, 656, 706, 756, 806, 826, 856, 1026, 1206, 1256 ALL FOR FAST HITCHES)

*** Truck icon indicates the item is shipped via truck freight. ***

Hitch & Drawbar Parts

Parts are not original equipment parts and are not sponsored, affiliated, or otherwise connected with any major brand.

A-398373R1 Latch, Telescoping Lift Arm 1.18 Lbs.



For Models: (100, 1026, 1066, 1086, 1206, 1256, 130, 140, 656, 666, 686, 706, 756, 766, 786, 806, 826, 856, 886, 986, HYDRO 186 ALL FOR CAT II 3POINT HITCH)

A-398399R1 Latch, Telescoping Lift Arm 1.50 Lbs.



For Models: (1066, 1086, 1466, 1468, 1486, 1566, 1568, 1586, 986 ALL CAT II 3 POINT HITCHES), 88 SERIES CAT III HITCH

A-522839R1 Spring, Upper Latch 0.13 Lbs.



Dim/Info:
Used w/ A-393500R1 Latch.

For Models: 100 FARMALL, (1026, 1206 ALL 2PT Fast Hitch), (130, 140, 200 ALL FARMALL), (21026, 21206 ALL IH 2PT Fast Hitch), 230 FARMALL, 240 FARMALL & IH, (2504, 2544, 2606, 2656, 2706, 2756, 2806, 2826, 2856, 300 FARMALL, 330, 340, 350, 400 FARMALL, 450, 460, 504 ALL IH 2PT Fast Hitch), 544 2PT Fast Hitch, (560, 606 ALL IH 2PT Fast Hitch), 656 2PT Fast Hitch, 660 IH 2PT Fast Hitch, (666, 686 ALL 2PT Fast Hitch), 706 IH 2PT Fast Hitch, (756, 766 ALL 2PT Fast Hitch), 806 IH 2PT Fast Hitch, (826, 856, 966 AL

A-522840R2 Spring, Lower Latch 0.15 Lbs.



Dim/Info:
Used w/ A-393500R1 Latch.

For Models: 100 FARMALL, (1026, 1206 ALL 2PT Fast Hitch), (130, 140, 200 ALL FARMALL), (21026, 21206 ALL IH 2PT Fast Hitch), 230 FARMALL, 240 FARMALL & IH, (2504, 2544, 2606, 2656, 2706, 2756, 2806, 2826, 2856, 300 FARMALL, 330, 340, 350, 400 FARMALL, 450, 460, 504 ALL IH 2PT Fast Hitch), 544 2PT Fast Hitch, (560, 606 ALL IH 2PT Fast Hitch), 656 2PT Fast Hitch, 660 IH 2PT Fast Hitch, (666, 686 ALL 2PT Fast Hitch), 706 IH 2PT Fast Hitch, (756, 766 ALL 2PT Fast Hitch), 806 IH 2PT Fast Hitch, (826, 856, 966 AL

A-382193R1 Spring, Upper Latch 0.23 Lbs.
Used w/ A-382192R1, A-398373R1, & A-398399R1 Latches.

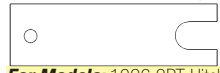

For Models: 1026 3PT Hitch, 1066, 1086, (1206, 1456 ALL 3PT Hitch), 1466, 1468, 1486, 1566, 1568, 1586, (21026, 21206, 21256, 21456, 2706, 2756, 2806, 2826, 2856 ALL 3PT Hitch), 3088, 3288, 3388, 3488, 3588, 3688, 3788, 5088, 5288, 5488, 6388, 6588, 6788, 706 3PT Hitch, 7110, 7120, 7130, 7140, 7150, 7210, 7220, 7230, 7240, 7250, (756, 766 ALL 3PT Hitch), 786, (806, 826, 856 ALL 3PT Hitch), 886, 8910, 8920, 8930, 8940, 8950, 966 3PT Hitch

A-382192R1 Spring, Lower Latch 0.28 Lbs.
Used w/ A-382192R1, A-398373R1, & A-398399R1 Latches.



For Models: 1026 3PT Hitch, 1066, 1086, (1206, 1456 ALL 3PT Hitch), 1466, 1468, 1486, 1566, 1568, 1586, (21026, 21206, 21256, 21456, 2706, 2756, 2806, 2826, 2856 ALL 3PT Hitch), 3088, 3288, 3388, 3488, 3588, 3688, 3788, 5088, 5288, 5488, 6388, 6588, 6788, 706 3PT Hitch, 7110, 7120, 7130, 7140, 7150, 7210, 7220, 7230, 7240, 7250, (756, 766 ALL 3PT Hitch), 786, (806, 826, 856 ALL 3PT Hitch), 886, 8910, 8920, 8930, 8940, 8950, 966 3PT Hitch

A-400836R1 Clevis, Lateral Limiter 2.08 Lbs.



Dim/Info:
7.310" Long

A-400835R1 Pipe, Inner 0.99 Lbs.



A-389369R1 Yoke 0.96 Lbs.



A-389370R11 Pin, Lockout 0.22 Lbs.

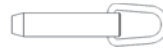

A-384852R1 Pin, Used In Front or Rear Yokes 0.22 Lbs.

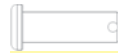

For Models: 2544, 2656, 544, 656, 664, 666, 686, HYDRO 70, HYDRO 86

A-522820R23 Limiter, Lateral Sway 14.00 Lbs.
Replaces: 522820R11, 522820R22



For Models: (400, 450, 560, 660 ALL W/FAST HITCH)

A-406242R2 Complete Sway Limiter Assembly 7.00 Lbs.

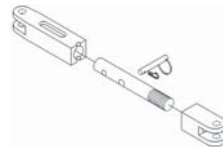

A-406244R2 Yoke, Front 1.50 Lbs.



A-386198R1 Stud 2.00 Lbs.



A-383363R11 Pin, Lockout 0.26 Lbs.



A-406243R1 Yoke, Rear 3.00 Lbs.

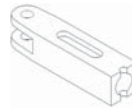

For Models: HYDRO 100, HYDRO 186, 706, 756, 766, 786, 806, 826, 856, 886, 966, 986, 1026, 3088, 3288, 3488, 3688

A-384852R1 Pin, Used In Front or Rear Yokes 0.22 Lbs.

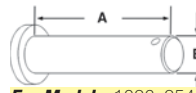

Dim/Info:
A - 2.05" Long
B - .621" Dia.

For Models: 1026, 2544, 2656, 3088, 3288, 3688, 544, 656, 664, 666, 686, 706, 756, 766, 786, 806, 826, 856, 886, 966, 986, HYDRO 100, HYDRO 186, HYDRO 3488, HYDRO 70, HYDRO 86

AGCO
ALLIS
CHALMERS
DEUTZ
MASSEY
FERGUSON
WHITE/
OLIVER

CNH
CASE-IH

FORD / NEW
HOLLAND
FIAT

BELARUS

BOBCAT

JCB

JOHN
DEERE

KUBOTA

LANDINI

LEYLAND

LONG

MCCORMICK

OTHER

RENAULT

SAME

VALTRA

VERSATILE

YANMAR











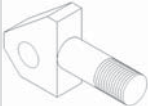





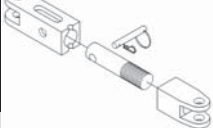

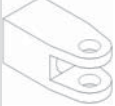
ZETOR

SCHWARTZ
SPEECO

*** Truck icon indicates the item is shipped via truck freight.***

Hitch & Drawbar Parts

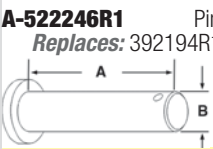
Parts are not original equipment parts and are not sponsored, affiliated, or otherwise connected with any major brand.

AGCO ALLIS CHALMERS	A-382397R1	Eyebolt, Rear Stabilizer	0.70 Lbs.		A-67693C1	Pivot Pin	1.04 Lbs.				
	<i>For Models:</i> HYDRO 100, HYDRO 186, 706, 756, 766, 786, 806, 826, 856, 886, 966, 986, 1026, 3088, 3288, 3488, 3688					<i>For Models:</i> (1066, 1086, 1206, 1256, 1456, 1466, 1468, 1486, 1566, 1568, 1586, 3388, 3588, 3788 ALL USED W/A-406250R1 SWAY LIMITER)					
	A-382390R1	Eyebolt, Front Stabilizer	0.72 Lbs.				A-389362R1		Stabilizer Control Arm	19.90 Lbs.	
	Used w/ A-382386R2 stabilizer control arm.						<i>For Models:</i> 2544, 2656, 544, 656, 664, 666, 686, HYDRO 70, HYDRO 86				
MASSEY FERGUSON		<i>For Models:</i> HYDRO 70, HYDRO 86, HYDRO 100, HYDRO 186, 544, 656, 664, 666, 686, 706, 756, 766, 786, 806, 826, 856, 886, 966, 986, 1026, 2544, 2656, 2706, 2756, 2806, 2826, 2856, 3088, 3288, 3488, 3688, 21026		A-406250R1	Complete Sway Limiter Assembly	9.00 Lbs.					
		Consist of the following parts plus center pin.				A-382386R2		Stabilizer Control Arm	14.50 Lbs.		
								<i>For Models:</i> (21026, 2706, 2756, 2806, 2826, 2856, 3088, 3288, 3488, 3688, 706, 756, 766, 786, 806, 826, 856, 886, 966, 986, HYDRO 100, HYDRO 186 ALL FOR CAT II 3 POINT HITCH)			
CNH		A-406249R1	Yoke, Front (3.980" long)	2.50 Lbs.	A-392183R1	Stabilizer Control Arm	23.00 Lbs.				
CASE-IH						<i>For Models:</i> (1066, 1086, 1206, 1256, 1456, 1466, 1468, 1486, 1566, 1568, 3388, 3588 ALL FOR CAT III 3 POINT HITCH)					
FORD / NEW HOLLAND		A-406247R1	Stud (1.250" dia.)	1.65 Lbs.	A-922662*	Bracket, Stabilizer	2.20 Lbs.				
FIAT						<i>Replaces:</i> K915133					
BELARUS		A-392193R21	Pin, Lockout	0.24 Lbs.	A-K922664*	Bracket, Stabilizer	2.30 Lbs.				
BOBCAT						<i>Replaces:</i> K919668					
JCB		A-406248R2	Yoke, Rear (6.125" long)	4.00 Lbs.	A-114418A2	Support Assembly (RH)	29.80 Lbs.				
JOHN DEERE						<i>For Models:</i> 990, 995, 996, 1290, 1294, 1390, 1394					
KUBOTA		A-522246R1	Pin, Used In Front or Rear Yoke	0.36 Lbs.	A-1533545C2	Support Assembly (LH)	29.80 Lbs.				
LANDINI						<i>For Models:</i> MX100, MX110, MX120, MX135					
LEYLAND		A-522246R1	Pin, Used In Front or Rear Yoke	0.36 Lbs.	A-383362R2	Pivot Pin	0.84 Lbs.				
LONG						<i>This part is used w/ A-382386R2 Stabilizer control arm.</i>					
McCORMICK					<i>For Models:</i> 1066, 1086, 1206, 1256, 1456, 1466, 1468, 1486, 1566, 1568, 1586, 3388, 3588, 3788						
OTHER		A-392195R1	Eyebolt, Rear Stabilizer	1.08 Lbs.	<i>For Models:</i> HYDRO 100, 706, 756, 766, 806, 826, 856, 966, 1026, 1066, 1206						
RENAULT											
SAME											
VALTRA											
VERSATILE											
YANMAR											
ZETOR											
SCHWARTZ SPEECO											

*** Truck icon indicates the item is shipped via truck freight. ***

Hitch & Drawbar Parts

Parts are not original equipment parts and are not sponsored, affiliated, or otherwise connected with any major brand.

A-3620019R1 Stabilizer Chain Assembly 5.50 Lbs.

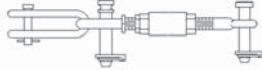

For Models: 275, 474, 484, 485, 574, 584, 585, 674, 684, 685, 695, 784, 785, 795, 885, 895, 995

A-389360R1 Drawbar Support Casting 47.00 Lbs.

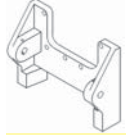

Dim/Info:
For 3 PT equip. tractors.
1" x 3.500" x 16.000"

For Models: 544, 656, 666, 686, HYDRO 70, HYDRO 86

A-389064R1 Drawbar Support Casting 46.32 Lbs.

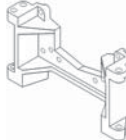

Dim/Info:
For Fast-Hitch Tractors

For Models: 1026, 706, 756, 766, 806, 826, 856, 966

A-389065R1 Support Plate 14.30 Lbs.

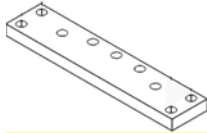

For Models: (1026, 21026 ALL W/ Independent Swinging Drawbar & 2 Pt. Hitch), 2706 W/ Ind. Swing Drawbar & 2 Pt. Hitch; Farmall 19250>, IH 300>, (2756, 2806, 2826, 2856 ALL W/ Independent Swinging Drawbar & 2 Pt. Hitch), 706 W/ Ind. Swing Drawbar & 2 Pt. Hitch; Farmall 19250>, IH 300>, 756 W/ Independent Swinging Drawbar & 2 Pt. Hitch, 766 W/ Independent Swinging Drawbar & 2 Pt. Hitch; SN <13892, (806, 826, 856 ALL W/ Independent Swinging Drawbar & 2 Pt. Hitch), 966 W/ Independent Swinging Drawbar & 2 Pt. Hi

A-539749R1 Support Casting 38.06 Lbs.
Replaces: 400713R1



Dim/Info:
For 2 piece drawbar.
1" x 3.500" x 16.500"

A-400714R1 Support Plate 15.00 Lbs.

For Models: 1026, 1206, 706, 756, 766, 806, 826, 856, 966

A-383385R3 Support Casting 36.60 Lbs.
Replaces: 72392C1

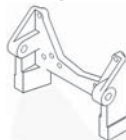

Dim/Info:
For 1 piece drawbar.
10.250" High
plate 1" x 3.5" x 16.5"

A-400714R1 Support Plate 15.00 Lbs.

For Models: 1026, 706, 756, 766, 826, 856, 966, HYDRO 86

A-406468R31 Support, Drawbar 13.16 Lbs.



For Models: 2400A, 2500A, 385, 454, 464, 485, 495, 574, 585, 595, 674, 684, 685, 695, 884, 885, 895

A-381707R21 Support, Front Drawbar 52.00 Lbs.



For Models: 1026, 21026, 2706, 2756, 2826, 2856, 706, 756, 826, 856, 766 SN <-13892, 966 SN <-27089, 806, 2806

A-57654D Pin, Front Drawbar 0.95 Lbs.
Check size before ordering.



Dim/Info:
3.437" Long

A-49139D Lock Plate, Drawbar Pin 0.10 Lbs.

For Models: H S/N 39937>, HV, HYDRO 70, HYDRO 86, SUPER H, 300, 350, 404, 460, 504, 544, 606, 656, 664, 666, 686, 706, 756, 766, 806, 826, 856, 966, 1026, 1066, 1206, 1256, 1456, 1466, 1468, 1566, 1568, 2404, 2504, 2544, 2606, 2656, 2706, 2756, 2826, 2856, 21026, 21206, 21256, 21456

A-108505C1 Pin, Front Drawbar 2.02 Lbs.
Check size before ordering.



Dim/Info:
4.965" Long

For Models: 1066, 1086, 1466, 1468, 1486, 1566, 1568, 1586, 3088, 3288, 3388, 3588, 3688, 3788, 6388, 6588, 6788, 766, 786, 886, 966, 986

A-65301C1 Block, Drawbar Stop 1.32 Lbs.
2 Used



For Models: 766 SN <-13892, W/2 PIECE SWINGING DRAWBAR, 966 SN <-27089, W/2 PIECE SWINGING DRAWBAR, (2756, 2856, 756, 856 ALL W/2 PIECE SWINGING DRAWBAR)

A-65300C1 Block, Drawbar Stop 1.49 Lbs.
2 Used



For Models: 1466 SN <-24402, W/2 PIECE SWINGING DRAWBAR, 1066 SN <-45051, W/2 PIECE SWINGING DRAWBAR, (1468, 1566 ALL SN <-7114, W/2 PIECE SWINGING DRAWBAR), 1568 SN <-7205, W/2 PIECE SWINGING DRAWBAR

A-108507C1 Block, Drawbar Stop 0.50 Lbs.



For Models: (1086, 1486, 1566, 1568, 1586, 3088, 3288, 3388, 3488, 3588, 3688, 3788, 786, 886, 986, HYDRO 186 ALL W/ 1 pc. Swinging Drawbar), 1066 SN 45052> W/ 1 pc. Swinging Drawbar, 1466 SN 24403> W/ 1 pc. Swinging Drawbar, 1468 SN 10084> W/ 1 pc. Swinging Drawbar, 766 SN 13893> W/ 1 pc. Swinging Drawbar, 966 SN 27090> W/ 1 pc. Swinging Drawbar, HYDRO 100 SN 10431> W/ 1 pc. Swinging Drawbar

A-58657DA Pin, Front Drawbar 1.52 Lbs.



For Models: (M, MD, SUPER M, SUPER MD, 400, 450, 560, 660 ALL FOR MODELS WITH SWINGING DRAWBAR)

A-439-51644* Pin, Front Drawbar 0.76 Lbs.



Dim/Info:
Pin Dia.: 1.000"
Useable Length: 2.500"
Overall Length: 3.120"
Head Dia.: 1.500"

For Models: HYDRO 70, HYDRO 86, 544, 656, 664, 666, 686, (4100, 4156, 4166, 4186 ALL Drawbar Support Arm Pin), 2544, 2656

AGCO
ALLIS
CHALMERS
DEUTZ
MASSEY
FERGUSON
WHITE/
OLIVER

CNH
CASE-IH

FORD / NEW
HOLLAND
FIAT

BELARUS

BOBCAT

JCB

JOHN
DEERE

KUBOTA

LANDINI

LEYLAND

LONG

McCORMICK

OTHER

RENAULT

SAME

VALTRA

VERSATILE

YANMAR

ZETOR

SCHWARTZ
SPEECO

*** Truck icon indicates the item is shipped via truck freight.***

Hitch & Drawbar Parts

Parts are not original equipment parts and are not sponsored, affiliated, or otherwise connected with any major brand.

A-357530R1 Drawbar 24.39 Lbs.



Dim/Info:
3/4" Thick
50 1/2" Center to Center

For Models: H, SUPER H

AGCO
ALLIS
CHALMERS

A-357529R1 Drawbar, Swinging 37.82 Lbs.



Dim/Info:
1" Thick
52 1/4" Center to Center

For Models: M, MD, SUPER M, SUPER MD

DEUTZ
MASSEY
FERGUSON

A-3111194R1 Drawbar, Offset 27.72 Lbs.
(1) 1.180" Dia. hole 1.312" from front

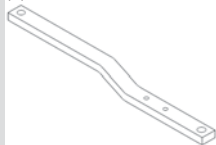

Dim/Info:
35.750" Long
2.375" Wide
1.187" High
2.125" Offset

For Models: 2300A, 354, 364, 384, 444

WHITE/
OLIVER

A-3116100R2 Drawbar 23.78 Lbs.
(2) 1.000" Dia. holes @ 1.187" 3.187" from front.



Dim/Info:
38.000" Long
2.000" Wide
1.187" High

A-406469R1 Pin, Front Drawbar w/ early S/N (2.951" long) 0.58 Lbs.
A-1502366C1 Pin, Front Drawbar w/ late S/N (3.221" long) 0.63 Lbs.

For Models: 385, 484, 485

CNH
CASE-IH

A-406467SPL Drawbar 31.06 Lbs.
(4) 1.008" Dia. holes @ 1.200", 3.200", 4.900", 6.900" from front.



Dim/Info:
38.000" Long
2.250" Wide
1.375" High

FORD / NEW
HOLLAND
FIAT

A-406469R1 Pin, Front Drawbar w/ early S/N (2.951" long) 0.58 Lbs.
A-1502366C1 Pin, Front Drawbar w/ late S/N (3.221" long) 0.63 Lbs.

For Models: 2400, 385, 395, 454, 464, 485, 495, 574, 585, 595, 674, 684, 685, 885, 895

BELARUS
BOBCAT
JCB
JOHN
DEERE

A-375986R1 Drawbar, Swinging 38.00 Lbs.

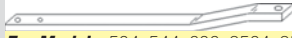

For Models: 504, 544, 606, 2504, 2544, 2606

KUBOTA

A-389099R1 Stub Drawbar 25.90 Lbs.
(2) 1.040" Dia. holes @ 6.390" & 8.390" from front.

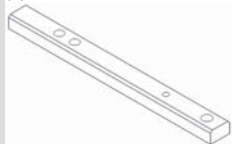

Dim/Info:
26.250" Long
2.500" Wide
1.500" High

LANDINI
LEYLAND
LONG

For Models: 544, 656, 666, 686, HYDRO 70, HYDRO 86

McCORMICK

A-389100R11 Tube, Front Drawbar 30.10 Lbs.

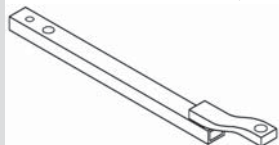

Dim/Info:
25.500" Tube Length

OTHER

RENAULT

SAME

VALTRA

VERSATILE

YANMAR

ZETOR

SCHWARTZ
SPEECO

A-393501R11 Tube, Front Assembly 36.00 Lbs.



Dim/Info:
34.875" Long

A-57654D Pin, Front Drawbar 0.95 Lbs.

A-49139D Lock Plate, Drawbar Pin 0.10 Lbs.

For Models: (1026, 756, 766, 826 ALL SN <-13892), 966 SN <-270896, 706 W/3PT & SN 19250->, 806 W/3PT, SN 14500-23000, 856 2PT or 3PT & Diesel Custom SN 21116->

A-397065R1 Drawbar, Stub 25.84 Lbs.
(1) 1.040" Dia. hole 10.500" from front of bar.

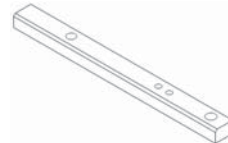

Dim/Info:
26.250" Long
2.500" Wide
1.500" High

A-389428R1 Pin, Front Drawbar 0.98 Lbs.

For Models: (1026, 756, 766, 826 ALL SN <-13892), 966 SN <-270896, 706 W/3PT & SN 19250->, 806 W/3PT, SN 14500-23000

A-381706R2 Drawbar 46.54 Lbs.
(2) 1.165" Dia. holes @ 1.500" & 10.500" from front. Note: This bar can replace 2 piece assy. (397065R1 bar & 393501R11 tube, shown above).

Replaces: 393150R1



Dim/Info:
45.750" Long
2.500" Wide
1.500" High

A-57654D Pin, Front Drawbar 0.95 Lbs.

A-49139D Lock Plate, Drawbar Pin 0.10 Lbs.



For Models: 1026, 706, 756, 806, 826, 856, 766 SN <-13892, 966 SN <-270896

A-397066R1 Drawbar 38.66 Lbs.
(2) 1.040" Dia. holes 22.500" & 28.000" from front of bar.



Dim/Info:
38.750" Long
2.500" Wide
1.500" High

A-389428R1 Pin, Front Drawbar 0.98 Lbs.

For Models: (1206, 1256, 1456, 766 ALL SN 13892->), 966 SN 270896->

A-391988R91 Tube, Front Assembly 51.04 Lbs.



Dim/Info:
47.500" Long

A-57654D Pin, Front Drawbar 0.95 Lbs.

A-49139D Lock Plate, Drawbar Pin 0.10 Lbs.

For Models: 1066, 1206, 1256, 1456, 1468

*** Truck icon indicates the item is shipped via truck freight. ***

Hitch & Drawbar Parts

Parts are not original equipment parts and are not sponsored, affiliated, or otherwise connected with any major brand.

A-535799R1 Drawbar, Rear 36.34 Lbs.
1.145" Dia. hole 1.5" from end, .687" Dia. hole 5.51" from end, .656" Dia. hole 6.92" from end, 1.031" Dia. hole 14.12" from end.



Dim/Info:
38.750" Long
2.500" Wide
1.500" High

For Models: 1066

A-223351 Drawbar 63.00 Lbs.
(1) 1.385" Dia. hole, 1.500" from front.
Replaces: 72476C1, 103502C1



Dim/Info:
56.000" Long
2.750" Wide
1.500" High

A-108505C1 Pin, Front Drawbar 2.02 Lbs.
For Models: 1026, 1066, 1086, 1206, 1256, 1456, 1466, 1486, 1566, 1586, 706, 756, 766, 786, 806, 826, 856, 886, 966, 986

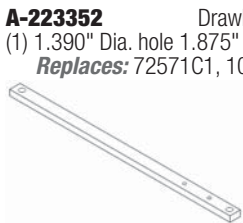

A-223352 Drawbar 66.00 Lbs.
(1) 1.390" Dia. hole 1.875" from front.
Replaces: 72571C1, 108504C1



Dim/Info:
58.125" Long
2.750" Wide
1.500" High

A-223353 Drawbar w/ Hammerstrap Holes 76.00 Lbs.
(3) 1.390" Dia. holes @ 1.750", 5.937", 15.312" from front.



Dim/Info:
62.250" Long
3.000" Wide
1.500" High

A-108505C1 Pin, Front Drawbar 2.02 Lbs.

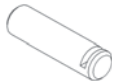

A-108506C1 Hammerstrap 8.68 Lbs.



A-483858R1 Spacer, Hammerstrap 0.05 Lbs.



For Models: 1026, 1066, 1086, 1206, 1256, 1456, 1466, 1486, 1566, 1586, 706, 756, 766, 786, 806, 826, 856, 886, 966, 986

A-142617C4 Drawbar 83.00 Lbs.



Dim/Info:
58.500" Long
3.00" Wide
1.500" Thick
2.250" Offset

For Models: 5088

A-142616C2 Drawbar, Straight 72.00 Lbs.



Dim/Info:
60.500" Long
3.00" Wide
1.500" Thick

For Models: 5288, 5488

A-1332020C3 Drawbar, Straight 51.60 Lbs.
Drawbar does not have cross hole.



Dim/Info:
50.750" Long
2.375" Wide
1.562" Thick

For Models: 5120, 5130, 5140, 5220, 5230, 5240, 5250 ALL Early Production

A-1286970C3 Drawbar 70.00 Lbs.
(4) front holes @ 1.445", 5.445", 9.445", 12.930" front front.



Dim/Info:
58.690" Long
3.000" Wide
1.500" Thick

For Models: 7110, 7120, 7210, 7220, 8910, 8920

A-1286969C3 Drawbar 85.00 Lbs.
(4) front holes @ 1.406", 5.473", 9.473", 14.850" front front.



Dim/Info:
60.620" Long
3.000" Wide
1.750" Thick

For Models: 7130, 7140, 7150, 7230, 7240, 7250, 8930, 8940, 8950

A-294015A3 Drawbar, Heavy Duty 88.00 Lbs.
Replaces: 294015A2, 294015A1



For Models: MX180, MX200, MX220, MX240, MX270, 8910, 8920, 8930, 8940, 8950

A-149842C2* Hammer Strap; Drawbar 9.10 Lbs.
Used W/ 142617C4 Drawbar



For Models: 5088

A-1286983C1 Spacer, Drawbar Hammerstrap 6.63 Lbs.

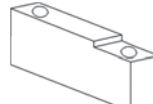

For Models: 7130, 7140, 7150, 7230, 7240, 7250, 8930, 8940, 8950

A-1286984C1 Hammerstrap, Drawbar 13.45 Lbs.

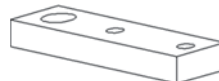

For Models: 7110, 7120, 7130, 7140, 7150, 7210, 7220, 7230, 7240, 7250, 8920, 8930, 8940, 8950

A-1348030C1 Hammerstrap, Drawbar 14.00 Lbs.



For Models: (7110, 7120, 7130, 7140, 7150 ALL SN JJA0023395>), 7210, 7220, 7230, 7240, 7250, 8910, 8920, 8930, 8940, 8950

A-1534262C1 Bracket, Drawbar 119.40 Lbs.

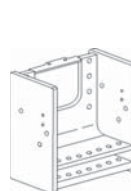

For Models: 5120, 5130, 5140, 5220, 5230, 5240, 5250

AGCO
ALLIS
CHALMERS
DEUTZ
MASSEY
FERGUSON
WHITE/
OLIVER

CNH
CASE-IH

FORD / NEW
HOLLAND
FIAT

BELARUS

BOBCAT

JCB

JOHN
DEERE

KUBOTA

LANDINI

LEYLAND

LONG

McCORMICK

OTHER

RENAULT

SAME

VALTRA

VERSATILE

YANMAR







ZETOR



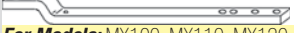

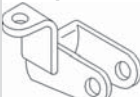

SCHWARTZ
SPEECO

*** Truck icon indicates the item is shipped via truck freight.***

Hitch & Drawbar Parts

Parts are not original equipment parts and are not sponsored, affiliated, or otherwise connected with any major brand.

AGCO ALLIS CHALMERS	A-1348194C1 Bracket, Drawbar (110 mm Hole) 42.50 Lbs. <i>Replaces:</i> 1332035C3, 1332035C2, 1332035C1	
	<i>For Models:</i> (5120, 5130, 5140, 5220, 5230, 5240, 5250 ALL SN <JJF1026487)	
	A-104642A2 Drawbar, Offset 53.00 Lbs.	
MASSEY FERGUSON	<i>For Models:</i> MX100, MX110, MX120, MX135, (5120, 5130, 5140, 5220, 5230, 5240, 5250 ALL Late Production)	
	A-A62428 Sway Block 23.72 Lbs.	
CNH CASE-IH	<i>For Models:</i> 730, 770, 830, 870, 970, 930 W/3PT HITCH	
	A-A26241 Eagle Hitch Lock (RH) 0.43 Lbs. <i>Replaces:</i> 6168A	
	<i>For Models:</i> 200B, 300, 300B, 310, 310C, 320B, 330, 400B, 420, 420B, 420BD, 425, 430, 500B, 600B, 630, 700, 800	
FIAT	A-A26242 Eagle Hitch Lock (LH) 0.44 Lbs. <i>Replaces:</i> 6169A	
	<i>For Models:</i> 200B, 300, 300B, 310, 310C, 320B, 330, 400B, 420, 420B, 420BD, 425, 430, 500B, 600B, 630, 700, 800	
BELARUS	A-A26240 Eagle Hitch Latch (RH/LH) 1.70 Lbs. <i>Replaces:</i> 6167A	
	<i>For Models:</i> 200B, 300, 300B, 310, 310C, 320B, 330, 400B, 420, 420B, 420BD, 425, 430, 500B, 600B, 630, 700, 800	
JOHN DEERE	A-A57201 Bracket, Drawbar 18.00 Lbs. NOTE: This part fits tractors w/o 3 point hitch.	
	<i>For Models:</i> 1030, 1070, 730, 830, 930, 970	
McCORMICK	A-A59603 Bracket, Drawbar 28.00 Lbs. This part fits tractors w/ 3 point hitch.	
	<i>For Models:</i> 1070, 1175, 770, 870, 970	
VALTRA	A-A65750 Drawbar 39.00 Lbs. Must use A60417 hanger. <i>Replaces:</i> A60426	
	<i>For Models:</i> 200, 230, C, SUPER C	
ZETOR	A-A65762 Pin, Front Drawbar 1.15 Lbs. <i>For Models:</i> 1070, 970	<i>Dim/Info:</i> 45.875" Long 2.500" Wide 1.250" Thick 1.067" Dia. Front

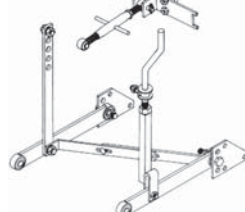
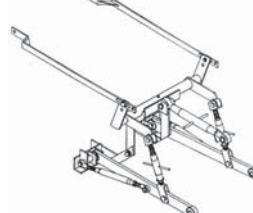
A-A60417 Bracket, Drawbar Hanger 1.80 Lbs. Used w/ A65750 Drawbar.	
<i>For Models:</i> 1070, 1175, 770, 870, 970	
A-A160849 Drawbar w/ 4.250" Offset 79.00 Lbs. (1) 1.281" Dia. Hole, 1.750" from end. <i>Replaces:</i> A63591, A65753	
<i>For Models:</i> 1270 SN 8717277->, 1370, 1570, 2390, 2394, 2590, 2594, 3394, 3594	<i>Dim/Info:</i> 53.000" Long 3.000" Wide 1.750" Thick
A-A65748 Pin, Front Drawbar 1.62 Lbs.	
<i>For Models:</i> 1270 SN 8717277->, 1370, 1570, 2390, 2394, 2590, 2594, 3394, 3594	
A-A61557 Strap, Hammer 11.68 Lbs.	
<i>For Models:</i> 1090, 1170, 1175, 1270, 1370, 1570, 1896, 2090, 2094, 2096, 2290, 2294, 2390, 2394, 2590, 2594, 3294, 3394, 3594	
A-A135435 Roller, Drawbar 2.88 Lbs.	
<i>For Models:</i> 1570, 1896, 2090, 2094, 2096, 2290, 2294, 2390, 2394, 2590, 2594, 3294, 3394, 3594, (1270, 1370 ALL W/ SN 8800875->)	
A-A137939 Drawbar 48.40 Lbs. (4) holes @ 1.500", 5.500", 7.000", & 8.750" from front.	
<i>For Models:</i> 1896, 2090, 2094, 2096, 2290, 2294	<i>Dim/Info:</i> 55.785" Long 2.500" Wide 1.250" Thick
A-49A317 3-pt Hitch, FD, Cat I 85.00 Lbs.	
<i>For Models:</i> (100, 130, 140, SUPER A ALL With standard pull-type drawbar)	
A-49A307 3-pt. Hitch 90.02 Lbs. Cat. I (Uses existing hydraulic lift)	
<i>For Models:</i> 200, 230, C, SUPER C	

*** Truck icon indicates the item is shipped via truck freight. ***

Hitch & Drawbar Parts

A-49A305

3-pt Hitch

130.00 Lbs.



Cat. I/II (Requires two 308DU Hyd. Cylinders.)

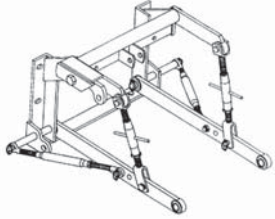

For Models: M, MD, SUPER M, SUPER MTA, 400, 450, 460, 504, 560, (544, 656 ALL w/ spacer #861188)

A-49A306

2-pt Hitch Conversion Kit

59.00 Lbs.

26" w/ exposed round rockershaft (Note: For row crop tractors only).

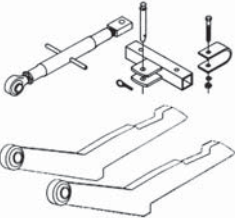

For Models: 300 FARMALL, 330, 340, 350, 450, 460, 560

A-1981280C1*

Clutch Plate, Sintered

1.00 Lbs.

Replaces: A67128, A62563, A58057



For Models:

Parts are not original equipment parts and are not sponsored, affiliated, or otherwise connected with any major brand.

AGCO
ALLIS
CHALMERS
DEUTZ
MASSEY
FERGUSON
WHITE/
OLIVER

CNH

CASE-IH

FORD / NEW
HOLLAND

FIAT

BELARUS

BOBCAT

JCB

JOHN
DEERE

KUBOTA

LANDINI

LEYLAND

LONG

McCORMICK

OTHER

RENAULT

SAME

VALTRA

VERSATILE

YANMAR

ZETOR

SCHWARTZ
SPEECO

*** Truck icon indicates the item is shipped via truck freight.***